

Part 2 Almaz, Salyut, and Mir

2.1 Overview

Figure 2-1 is a space station family tree depicting the evolutionary relationships described in this section.

2.1.1 Early Concepts (1903, 1962)

The space station concept is very old in Russia. Space pioneer Konstantin Tsiolkovskii wrote about space stations as early as 1903.¹ The first space station event relevant to this discussion occurred in March 1962, when Sergei Korolev's OKB-1 design bureau (ancestor of RKK Energia—until recently, NPO Energia) produced a report called “Complex for the Assembly of Space Vehicles in Artificial Earth Satellite Orbit (the Soyuz).” The report was

largely concerned with assembly in Earth orbit of a vehicle for circumlunar flight, but also described a small station made up of independently launched modules. Three cosmonauts were to reach the station aboard a manned transport spacecraft called Siber (or Sever) (“north”), shown in figure 2-2. They would live in a habitation module and observe Earth from a “science-package” module. Korolev's Vostok rocket (a converted ICBM) was tapped to launch both Siber and the station modules. In 1965, Korolev proposed a 90-ton space station to be launched by the N-1 rocket. It was to have had a docking module with ports for four Soyuz spacecraft.^{2,3}

2.1.2 Almaz: Conception (1964-1967)

However, the Korolev organization was preoccupied with preparing the Soviet entry in the Moon race with the United States. The task of developing the first space station fell to V. N. Chelomei's OKB-52 organization (ancestor of NPO Mashinostroyeniye).⁴ On October

12, 1964, Chelomei called upon his staff to develop a military station for two to three cosmonauts, with a design life of 1 to 2 years. They designed an integrated system: a single-launch space station dubbed Almaz (“diamond”) and a Transport Logistics Spacecraft (Russian acronym TKS) for reaching it (see section 3.3). Chelomei's three-stage Proton booster would launch them both. Almaz was to be equipped with a crew capsule, radar remote-sensing apparatus for imaging the Earth's surface, cameras, two reentry capsules for returning data to Earth, and an anti-aircraft cannon to defend against American attack.⁵ An interdepartmental commission approved the system in 1967. OKB-52 and its Branch No. 1 (ancestor of KB Salyut) divided responsibility for the system's components.⁶

2.1.3 First Space Stations (1970-1974)

Work on the Almaz stations proceeded apace, but the subsystems rapidly fell behind the original schedule. In February 1970, the Soviet Ministry of General Machine Building decided to transfer Almaz hardware and plans from Chelomei's bureau to Korolev's bureau.⁷ This was done in hopes it would permit the Soviet Union to launch a space station ahead of the U.S. Skylab project.⁸ The transfer was less physical than administrative, because both Energia Soyuz and Mashinostroyeniye Almaz hardware were assembled in the Krunichev plant.

Using Soyuz hardware for subsystems and Almaz hardware for large components such as the hull, Korolev's bureau and OKB-52 Branch No. 1 completed the world's first space station, Long-Duration Station-1 (Russian acronym DOS-1), in just 12 months. DOS-1 was called Zarya (“dawn”) 1 until shortly before its launch, when it was realized that

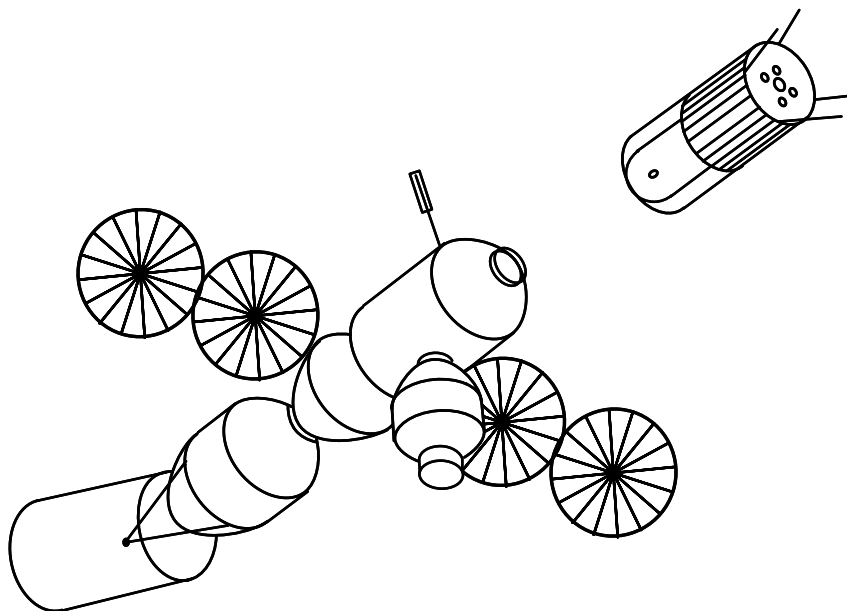

Figure 2-2. Conceptual drawing of Siber multimodule space station and Siber ferry (1962).

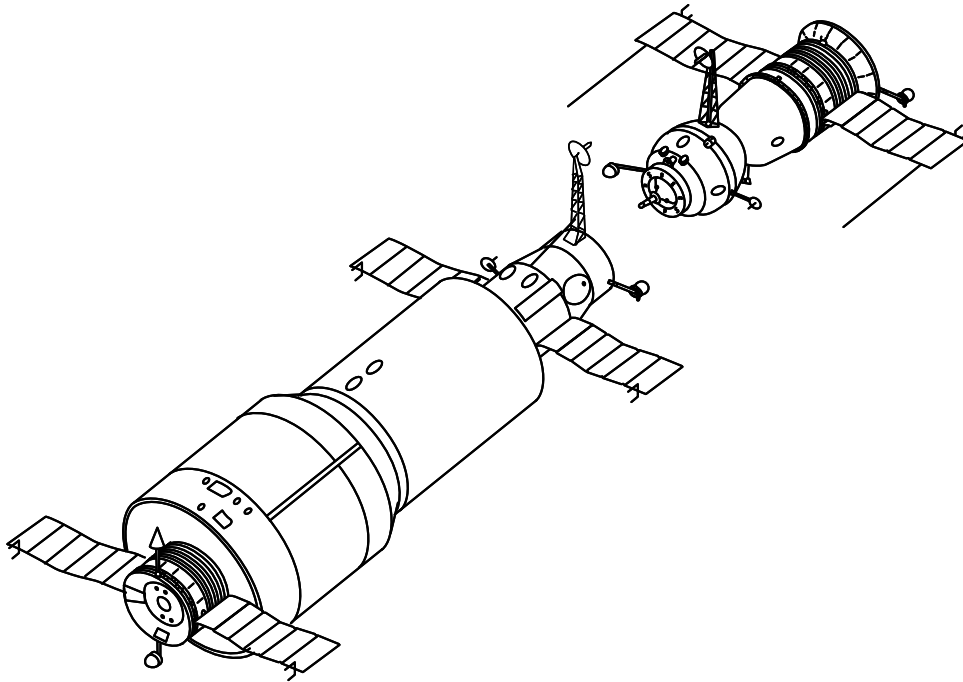

Figure 2-3. Salyut 1. Visible at the rear of the station (left) is the Soyuz-based propulsion module. A Salyut 1 Soyuz prepares to dock at the front of the station (right). Note the station's Soyuz-type solar arrays.

the name would cause confusion because Zarya was the code name for the TsUP. The station was hurriedly renamed Salyut (“salute”) 1 (figure 2-3).⁹ A three-stage Proton rocket boosted Salyut 1 into orbit (figure 2-4). The Soyuz 11 crew, which occupied Salyut 1 in June 1971, perished during return to Earth due to a Soyuz fault. Salyut 1 was followed by three more first-generation DOS-type stations, all based on Almaz components: one which failed to reach orbit in 1972 and received no official public designation (DOS-2), Cosmos 557 (DOS-3), which failed in orbit in 1973, and Salyut 4 (DOS-4) in 1974.¹⁰

The first-generation stations could not be refueled, and resupply was limited to what could be carried in the Soyuz orbital module. The first-generation stations each had only a single docking port.

2.1.4 Almaz: Cancellation (1970-1980)

The Almaz program continued in modified (abbreviated) form. TKS work continued, though Soyuz spacecraft were used to ferry cosmonauts to the Almaz stations.¹¹ Salyut 2, Salyut 3, and Salyut 5 were the Almaz 1, Almaz 2, and Almaz 3 stations. Salyut 2/Almaz 1 failed in orbit shortly after launch. NPO Mashinostroyeniye prepared Almaz 4 for launch in 1978, and proposed a 35-ton multiport Almaz station. Launching the Almaz multiport station would have required a new launch vehicle. However, the Almaz program was cancelled shortly before Almaz 4 (it would have been Salyut 7) was set to launch. The Almaz hardware was put in storage.¹² Manned spaceflight activities became concentrated at NPO Energia in 1980. Energia worked with KB Salyut to produce additional Salyut stations.¹³

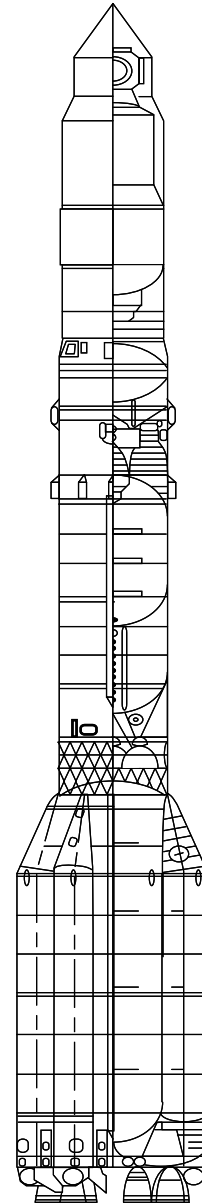

Figure 2-4. Partial cutaway of Proton configured for space station launch. The three-stage Proton rocket has launched all Soviet space stations and space station modules. Proton first flew as a two-stage vehicle in 1965. The three-stage version used to launch stations debuted in 1969 and was declared operational in 1970. All three stages burn UDMH and N_2O_4 propellants. The three-stage Proton can place 20,000 kg in a circular 185 km orbit at 51.6° of inclination.

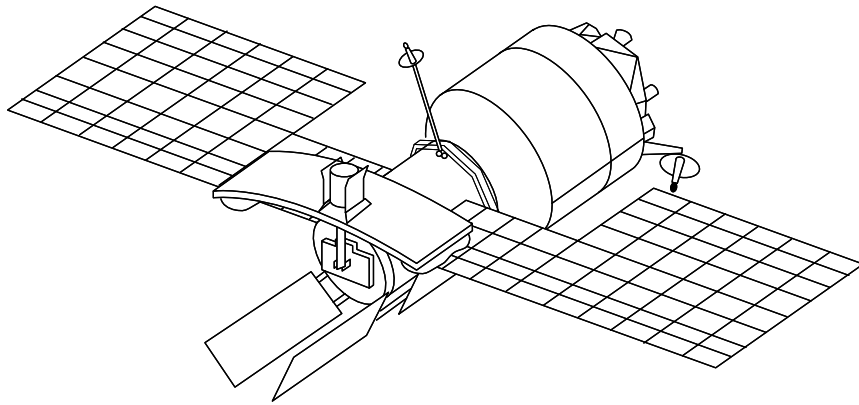

Figure 2-5. Almaz radar satellite.

2.1.5 Almaz: Conversion (1980-1993)

Mashinostroyeniye converted leftover Almaz hardware into unmanned satellites equipped with the ECOR-A Synthetic Aperture Radar (SAR) system for imaging the Earth's surface. The first such satellite was lost in 1985, after its Proton booster failed. The second, Cosmos 1870, was an experimental prototype. It operated from July 1987 to July 1989.¹⁴ The latest satellite in the series was called Almaz 1, thereby producing confusion among persons aware of the Salyut 2/Almaz 1 space station. Almaz 1 (figure 2-5) returned images from March 1991 to October 1992.¹⁵ In September 1992, Valentin Etkin, the chief of the Department of Applied Space Physics of the Russian Academy of Sciences Space Research Institute, described a further application of Almaz hardware. He called for a "Space Laboratory for the Study of Earth as an Ecological System" based on Almaz. The system would consist of three or four Almaz-derived satellites, each carrying 6.5 tons of scientific apparatus.¹⁶ According to a 1993 report, the Almaz 1V radar and optical Earth observation satellite is set for launch in June-July 1996, and the Almaz 2 satellite is being designed, with launch set for 1998.¹⁷

2.1.6 Shuttle-Salyut (1973-1978; 1980s)

The Apollo Soyuz Test Project (ASTP) grew from and rapidly superseded joint U.S.-Soviet talks on compatibility of future spacecraft,

but as early as October 1973, agreement was reached to resume the talks.¹⁸ In January 1975, Johnson Space Center Director Christopher Kraft outlined a possible future for U.S.-Soviet space cooperation, calling for a 1980 Shuttle docking with "whatever craft the U.S.S.R. intends to fly at that time." He suggested that a joint space station program could begin in 1983, and that Soviet cosmonauts could fly as Shuttle passengers.¹⁹

In October 1976, Acting NASA Administrator Alan Lovelace met with Intercosmos Council chairman Boris Petrov and other Soviet officials to discuss a Shuttle docking with a Salyut space station (figure 2-6). NASA would not commit to any program ahead of the approaching U.S. Presidential elections.²⁰ A formal agreement creating Shuttle-Salyut working groups was signed

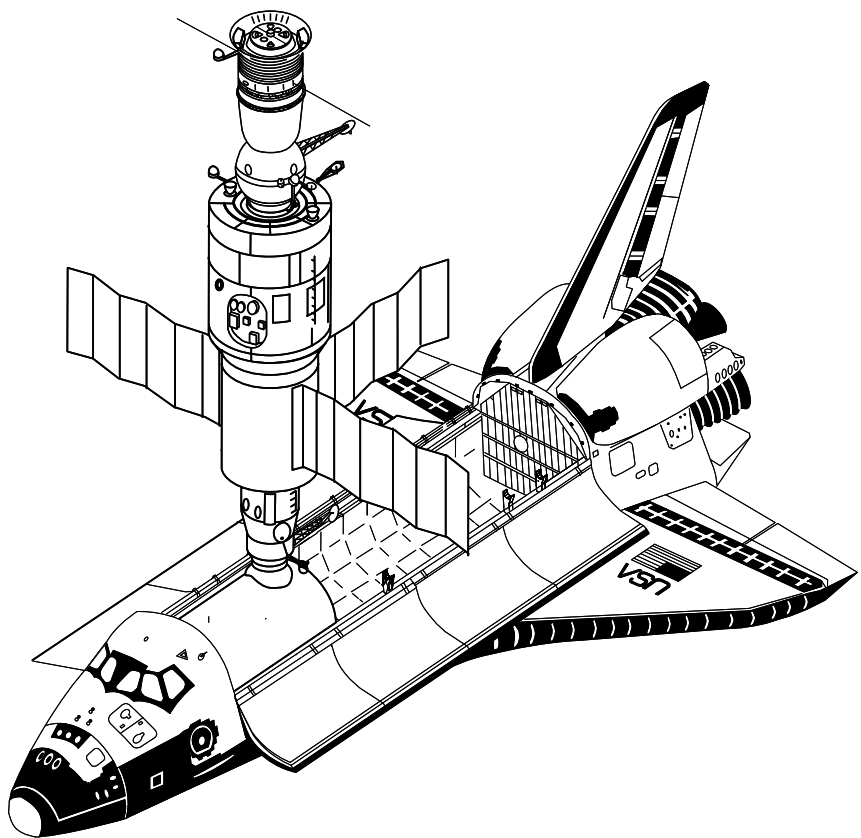

Figure 2-6. Conceptual drawing of Shuttle docked with Salyut.

between Lovelace and Anatoly Alexandrov, President of the Soviet Academy of Science, on May 11, 1977. The agreement pointed out the complimentary nature of the two countries' programs: Salyut was designed for long space stays, and Shuttle was designed for ferrying supplies and crews. The first Shuttle flight to a Soviet Salyut station was tentatively scheduled for 1981.²¹

The first Shuttle-Salyut working group meeting took place in Moscow in November 1977. However, the next meeting, set to take place in the U.S. in March-April 1978, was postponed. By late 1978, the U.S.-Soviet detente which made ASTP possible had run aground on human rights and technology transfer issues, and Shuttle-Salyut became dormant. However, occasionally during the 1980s, interest in Shuttle dockings with Soviet stations cropped up again. In 1985, the Reagan White House is said to have considered offering a Shuttle mission to aid in rescuing Salyut 7. In late 1987, NASA officials briefly considered having the Soviet shuttle dock with a

U.S. station, and the U.S. Shuttle dock with Mir.²²

2.1.7 Second-Generation Stations: Salyut 6 and Salyut 7 (1977-1986)

The second-generation stations Salyut 6 and Salyut 7 each had two docking ports. This permitted guest crews (known officially as Visiting Expeditions) to visit resident crews (known officially as Principal Expeditions). Visiting Expeditions could trade their Soyuz for the one already docked to the station, leaving a fresh vehicle for the Principal Expedition. Visiting Expeditions included cosmonauts from countries allied with or sympathetic to the Soviet Union. They were selected, trained, and flown as part of the Intercosmos program. Progress resupply craft used the aft docking port to deliver supplies to the second-generation stations.

2.1.8 Third-Generation Station: Mir (1986-present)

With Mir, the third-generation station, the Soviet space station effort has come full circle. The Korolev bureau's 1962 prospectus proposing a multimodular station reached fruition a quarter-century later, in 1987, with the permanent docking of the Kvant module to the Mir base block. In 1989-1990, the Kvant 2 and Kristall modules were added. At launch Mir was expected to be operational for 5 years. The base block is now in its ninth year. During that time it was almost always manned.

2.2 Salyut 1/DOS-1 (April 19-October 11, 1971)

Salyut 1 (figure 2-3) was the first manned space station. Most of its main components were originally built for OKB-52's Almaz program. Many of the smaller components were borrowed from the Soyuz program.

2.2.1 Salyut 1 Specifications

Length	15.8 m
Maximum diameter	4.15 m
Habitable volume	90 m ³
Weight at launch	18,900 kg
Launch vehicle	Proton (three-stage)
Span across solar arrays	about 10 m
Area of solar arrays	28 m ²
Number of solar arrays	4
Resupply carriers	Salyut 1-type Soyuz
Number of docking ports	1
Total manned missions	2
Total long-duration manned missions	1

2.2.2 Salyut 1 Notable Features

- Attitude control and orbit maintenance provided by a modified Soyuz service module (2.17 m long by 2.2 m dia). Station main propulsion system was a slightly modified Soyuz KDU-35 system. It had one single-nozzle 417-kg thrust primary engine and one two-nozzle 411-kg thrust backup, with four 10-kg engines for attitude control.²³ The service module was attached at the aft end of the large-diameter section of the work compartment. It could not be entered by the cosmonauts.
- Two habitable compartments. In front, the transfer compartment (2 m dia by 3 m long), containing the drogue docking apparatus and an EVA hatch; aft, the work compartment, which was divided into small-diameter (2.9 m dia by 3.8 m long) and large-diameter (4.15 m dia by 4.1 m long) sections, linked by a 1.2-m-long frustum.
- Main control panel (“astropost”) was a Soyuz control panel.
- Electricity provided by two pairs of Soyuz silicon photocell solar arrays.
- Electricity from the pair of solar arrays on a docked Soyuz (14 m² total area) augmented the station’s power supply through plugs in the docking collars. Total solar array area for the Salyut 1/Soyuz 11 complex came to 42 m².
- Micrometeoroid detector panels built into the station’s hull.
- Served as a space station engineering test bed. Cosmonauts conducted tests of the Salyut ion attitude control sensor, gyrodynes, and atmosphere, as well as tests aimed at developing new automatic docking system and antenna designs.
- Central small-diameter compartment served a wardroom function, with provisions for the cosmonauts’ spare time. These included a cassette player and cassettes, a sketch pad, and a small library of books. It also held a table for dining and working.
- Equipment compartments lining the inside of the hull covered by removable panels that formed the station’s interior walls. The walls each had different colors (light and dark gray, apple green, light yellow) to aid the cosmonauts in orienting themselves in weightlessness.
- Large-diameter work compartment equipped with a large conical structure housing astronomical instruments and other scientific and guidance equipment.
- Cosmonauts slept in sleeping bags attached to the walls of the large-diameter compartment, or in the orbital module of the docked Soyuz.
- Sanitation/hygiene unit located in the large-diameter section of the work compartment, within an enclosure with a ventilation system and washable walls.
- Large-diameter compartment had two refrigerators for food storage.

2.2.3 Salyut 1 Career

Entries below describe Salyut 1 operations during Soyuz missions to the station. For information on the Soyuz missions, see section 1.7.

Soyuz 10	April 22-24, 1971 (launch to landing)
Vladimir Shatalov, Alexei Yeliseyev, Nikolai Rukavishnikov Crew code name—Granit	
Hard docked, but its crew could not enter Salyut 1.	
Soyuz 11	June 7-29, 1971 (hard dock to undock)
Georgi Dobrovolski, Vladislav Volkov, Viktor Patsayev Crew code name—Yantar	
The Yantars performed astronomical observations using the Orion-1 telescope, grew plants in the Oasis hydroponics unit, and conducted extensive multispectral Earth resources photography. They appeared frequently on Soviet television. On June 27, the cosmonauts photographed the in-flight explosion of the third N-1 rocket. ²⁴ During reentry the crew died due to a Soyuz fault.	

2.3 Failed Salyuts (1972-1973)

2.3.1 DOS-2 (July 29, 1972)

A year after the Soyuz 11 failure, the Soviet Union felt ready to send crews to a second DOS-type station. Like Salyut 1, its large components were originally built for the Almaz program. Failure of the second stage of its three-stage Proton launch vehicle prevented the station from reaching orbit. It fell into the Pacific Ocean.

2.3.2 Salyut 2/Almaz 1 (April 3-May 28, 1973)

On April 3, 1973, the day of the Salyut 2 launch, the Soviet magazine *Nauka i Zhizn* published an interview with Soviet Academician Boris Petrov. In it he declared that lunar space stations would be established to act as bridgeheads for excursions to the lunar surface. He also predicted the advent of multimodular stations with crews of up to 120 people.²⁵ The failure of Salyut 2 a few days later must have made these goals seem distant indeed.

Salyut 2, the first Almaz station, reached orbit on April 3, 1973. Soon after, Salyut 2 lost stability and began tumbling. In 1992, Mikhail Lisun, backup cosmonaut for the Soyuz 24 flight to Almaz station

Salyut 5, attributed the loss of Salyut 2 to an electrical fire, followed by depressurization.²⁶ Salyut 2 broke up on April 14, and all trackable pieces reentered by May 28, 1973.

2.3.3 Cosmos 557/DOS-3 (May 11-22, 1973)

The third DOS-type station reached orbit just ahead of the U.S. Skylab workshop. Like DOS-2 and Salyut 1, it was based on a hull transferred from the Almaz program in 1970. Shortly after attaining orbit, the station suffered a failure in its attitude control system ion sensors, leading to depletion of most of its attitude control fuel supply. One account states that a command to raise its orbit was sent, but the station was in the wrong attitude, so it reentered.²⁷

2.4 Salyut 3/Almaz 2 (June 24, 1974-January 24, 1975)

Salyut 3 (figure 2-7) was the second Almaz station, and the first to be manned. Its mission was primarily military. For this reason, less information is available on Salyut 3 and Salyut 5 (the other successful Almaz station) than for the primarily civilian DOS-type Salyuts. Photos of the Almaz stations have surfaced only recently.

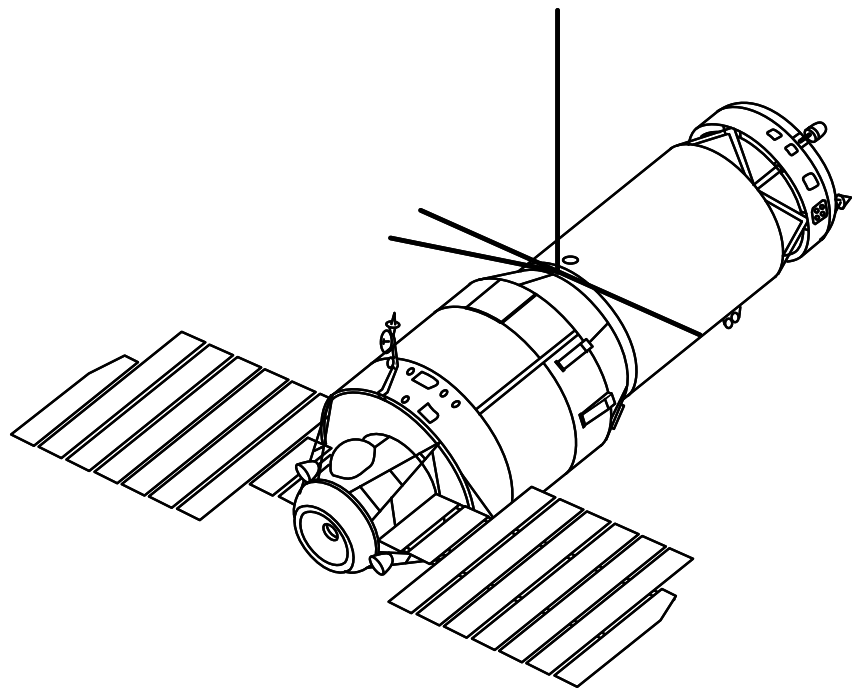

Figure 2-7. Salyut 3, the first successful Almaz space station. The drogue docking unit is at the rear of the station (left), between the two main engines.

2.4.1 Salyut 3 Specifications

Length	14.55 m
Maximum diameter	4.15 m
Habitable volume	90 m ³
Weight at launch	18,900 kg
Launch vehicle	Proton (three-stage)
Number of solar arrays	2
Resupply carriers	Soyuz Ferry
Number of docking ports	1
Total manned missions	2
Total long-duration manned missions	1
Number of main engines	2
Main engine thrust (each)	400 kg

2.4.2 Salyut 3 Notable Features

- From aft to fore, consisted of an airlock chamber, a large-diameter work compartment, and a small-diameter living compartment.
- Airlock chamber had four openings. The drogue unit of the pin and cone docking system filled the aft opening. The forward opening led into the large-diameter work compartment. On top of the airlock chamber was an EVA hatch (never used on an Almaz station). A hatch on the bottom led into the chamber from which a small Earth-return capsule could be ejected into space.²⁸
- Propulsion units were located on the aft end of the large-diameter compartment, on either side of the airlock chamber. These were specialized Almaz station engines, not the modified Soyuz units used with the early DOS Salyut stations.
- Unlike the early DOS Salyuts, Almaz had solar arrays which could track on the Sun in most station attitudes.
- The large-diameter portion of the station's work compartment was dominated by the Agat

Earth-observation camera, which had a 10-m focal length. This was used primarily for military reconnaissance purposes. The cosmonauts are said to have observed targets set out on the ground at Baikonur. Secondary objectives included study of water pollution, agricultural land, possible ore-bearing landforms, and oceanic ice formation.²⁹

- Cosmonauts could develop film from the Agat camera on the station. Important or interesting images were printed, then scanned by a TV imaging system for broadcast to Earth.³⁰ The cosmonauts needed as little as 30 minutes to shoot, develop, and scan a photograph.
- Other images were packed in the small Earth-return capsule, which was then ejected from the chamber under the spherical airlock. The capsule ejected by ground command. Ejection of the capsule signaled the end of an Almaz station's usefulness. Small engines deorbited the capsule and were then discarded. The parachute of Salyut 3's capsule opened at 8.4 km altitude.
- The small-diameter living compartment was separated from the work compartment by a bank of

12 tanks for storing gas—presumably oxygen for breathing.

- Cosmonauts had one standing bunk and one foldaway bunk in the station's living section. Salyut 3 was also equipped with a shower.
- Floor was covered with Velcro to aid the cosmonauts in moving about.
- Entertainment equipment included a magnetic chess set, a small library, and a tape player with cassettes.
- Exercise equipment included a treadmill and the Pingvin exercise suit.
- Tested the Priboy water regeneration system, which condensed water from the station's atmosphere.

2.4.3 Salyut 3 Career

Entries below describe Salyut 3 operations during Soyuz missions to the station. For more information on the Soyuz missions, see section 1.8.4.2. Dates are hard dock to undock; if no hard dock achieved, launch to landing.

Soyuz 14	July 4-19, 1974
Pavel Popovich, Yuri Artyukhin Crew code name—Berkut	
The Berkuts tested the suitability of Salyut 3 as a manned military reconnaissance satellite. They also tested Almaz station systems, such as the solar arrays. The cosmonauts exercised for 2 hours each day to counter the effects of weightlessness. Because of this, they were able to climb from their Soyuz Ferry descent module without assistance at the end of their flight.	

Soyuz 15	August 26-28, 1974
Gennadi Sarafanov, Lev Demin Crew code name—Dunay	
Failed to dock with Salyut 3.	

2.5 Salyut 4/DOS-4 (December 26, 1974-February 2, 1977)

2.5.1 Salyut 4 Specifications

Length	15.8 m
Maximum diameter	4.15 m
Habitable volume	90 m ³
Weight at launch	18,900 kg
Launch vehicle	Proton (three-stage)
Orbital inclination	51.6°
Area of solar arrays	60 m ²
Number of solar arrays	3
Electricity production	4 kW
Resupply carriers	Soyuz Ferry
Number of docking ports	1
Total manned missions	3
Total unmanned missions	1
Total long-duration manned missions	2

2.5.2 Salyut 4 Notable Features

- Structural layout very similar to that of Salyut 1. That is, it had a single docking port leading into a transfer compartment, a work compartment divided into small-diameter and large-diameter sections, and a propulsion and service module based on the Soyuz service module (figure 2-8). It was the last of four DOS-type stations based on hulls from the Almaz program.
- Stroka teleprinter allowed the TsUP to send hardcopy instructions to the Salyut 4 cosmonauts.
- Raketa (“rocket”) vacuum cleaner in transfer compartment.
- Rubberized fabric sleeve in the transfer compartment for providing ventilation to docked Soyuz Ferries.
- Cosmonauts spent a great deal of time conducting astrophysics observations. The large-diameter work compartment was dominated by a conical structure housing, among other things, the OST-1 25-cm solar telescope. It was equipped with a spectrograph and a diffraction spectrometer. The cosmonauts could recoat the mirror by remote control using the Zentis system. The solar telescope lacked a solar events alarm (as had Skylab) to alert the cosmonauts to valuable observation opportunities. The conical housing also held the Filin and RT-4 X-ray telescopes and the ITSK infrared telescope.³¹
- Cosmonauts also spent a great deal of time on experiments with application to closed-cycle life support systems. They cultivated peas and onions in the Oasis plant growth unit. They again tested a water regeneration system, which condensed about a liter of water from the station’s air each day.

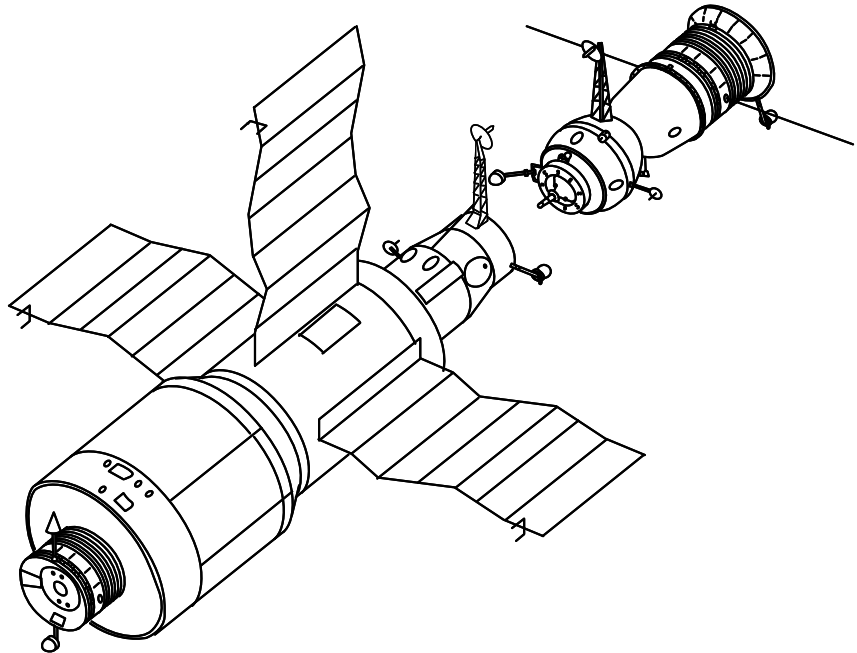

Figure 2-8. Salyut 4, the second DOS station to be manned.

- The Priboy water regeneration system was first tested on Salyut 3.
- Meteoroid measurement system with 4 m² of detectors built into the hull.
- Solar arrays larger than the Soyuz-based arrays on Salyut 1/ DOS-1. Salyut 4 had three steerable arrays with a combined surface area greater than the four nonsteerable arrays on Salyut 1.
- Exercise equipment included a treadmill (flown on previous stations) and a bicycle ergometer (flown for the first time on Salyut 4). The bicycle ergometer generated electricity which was stored for use by the station.³²
- Used Delta orientation/navigation system; also tested the Kaskad orientation/navigation system.
- For observing Earth, carried the KATE-140 and KATE-500 multispectral cameras, Spektru upper atmosphere analyzer, and other instruments.

2.5.3 Salyut 4 Career

Entries below describe Salyut 4 operations during Soyuz missions to the station. For more information on the Soyuz missions, see sections 1.8.4.3 and 1.10.4.1. Dates are hard dock to undock; if no hard dock achieved, launch to landing.

Soyuz 17

January 12-February 9, 1975

Alexei Gubarev, Georgi Grechko
Crew code name—Zenit

When Soyuz 17 docked, Salyut 4 was in an unusually high circular orbit at 350 km. Astrophysics was a major component of their mission (hence the high altitude). The Zenits discovered that the main mirror of the solar telescope had been ruined by direct exposure to sunlight when the pointing system failed. They resurfaced the mirror and worked out a way of pointing the telescope using a stethoscope, stopwatch, and the noises the moving mirror made in its casing.³³

“The April 5 Anomaly”

April 5, 1975

Vasili Lazerev, Oleg Makarov
Crew code name—Ural

Failed to dock with Salyut 4 due to a catastrophic Soyuz booster failure during ascent to orbit.

Soyuz 18

May 26-July 26, 1975

Pyotr Klimuk, Vitali Sevastyanov
Crew code name—Kavkaz

The Kavkaz crew carried out 90 scientific and engineering experiments, continuing the work of the Soyuz 17 crew. During their stay, they conducted two communications sessions with the ASTP Soyuz (Soyuz 19) crew.

Soyuz 20

November 17, 1975-February 16, 1976

First spacecraft to dock unmanned with a Salyut station. Carried life sciences experiments, qualified Soyuz for long-duration flights attached to a station, and served as proof-of-concept mission for Progress development.

2.6 Salyut 5/Almaz 3 (June 22, 1976-August 8, 1977)

Salyut 5 was the third Almaz station. Like Salyut 3/Almaz 2 (figure 2-7), which it closely resembled, its aims were primarily military.

2.6.1 Salyut 5 Specifications

Length	14.55 m
Maximum diameter	4.15 m
Habitable volume	100 m ³
Weight at launch	19,000 kg
Launch vehicle	Proton (three-stage)
Orbital inclination	51.6°
Number of solar arrays	2
Resupply carriers	Soyuz Ferry
Number of docking ports	1
Total manned missions	3
Total long-duration missions	2

2.6.2. Salyut 5 Notable Features

- Consisted of a spherical transfer module with four hatches, a large-diameter work compartment and a small-diameter living compartment.

- As with Salyut 3, the large Agat Earth-observation camera dominated the floor of the large-diameter work compartment. Agat images were used to compile maps; analyze tectonic structures; seek out oil, gas, and ore deposits; survey the sites of planned hydroelectric facilities; study formation of storms; and spot forest fires.³⁴ These activities were in addition to the station's primary Earth-observation objectives, which were military.

2.6.3 Salyut 5 Career

Entries below describe Salyut 5 operations during Soyuz missions to the station. For more information on the Soyuz missions, see section 1.8.4.4. Dates are hard dock to undock; if no hard dock achieved, launch to landing.

Soyuz 21

July 7-August 24, 1976

Boris Volynov, Vitali Zholobov
Crew code name—Baykal

The Salyut 5 crew's stay coincided with the start of the Siber military exercise in Siberia. The cosmonauts observed the exercise as part of an assessment of the station's military surveillance capabilities. They conducted only a few scientific experiments—these included first use of the Kristall furnace for crystal growth. Engineering experiments included propellant transfer system tests with implications for future Progress freighter operations. The Soyuz 21 crew seems to have left the station suddenly, ahead of their scheduled departure date. This has been attributed to a fire, an environmental control system

failure, and to health problems caused by fumes from chemicals used to develop film from the station's surveillance cameras.

Soyuz 23

October 14-16, 1976

Vyacheslav Zudov, Valeri Rozhdestvenski
Crew code name—Radon

Failed to dock with Salyut 5.

Soyuz 24

February 8-25, 1977

Viktor Gorbatko, Yuri Glazkov
Crew code name—Terek

The cosmonauts entered the station wearing breathing masks, apparently because of the problems encountered on Soyuz 21, but the air proved safe to breathe. The main purpose of their mission seems to have been to tie up loose ends generated by the precipitous departure of the Soyuz 21 crew. They loaded the Salyut 5 Earth-return capsule with samples and film. It detached the day after their departure from the station, on February 26, and was recovered. The Soyuz 24 crew conducted Earth observation and materials sciences experiments. They also conducted an air replacement engineering experiment with implications for future Progress freighter operations. Air was released from the forward end of the station while simultaneously being replaced from storage tanks in the Soyuz 24 orbital module.

**2.7 Salyut 6/DOS-5
(September 29, 1977-
July 29, 1982)**

Salyut 6 (figure 2-9) was the first second-generation DOS-type Salyut space station.

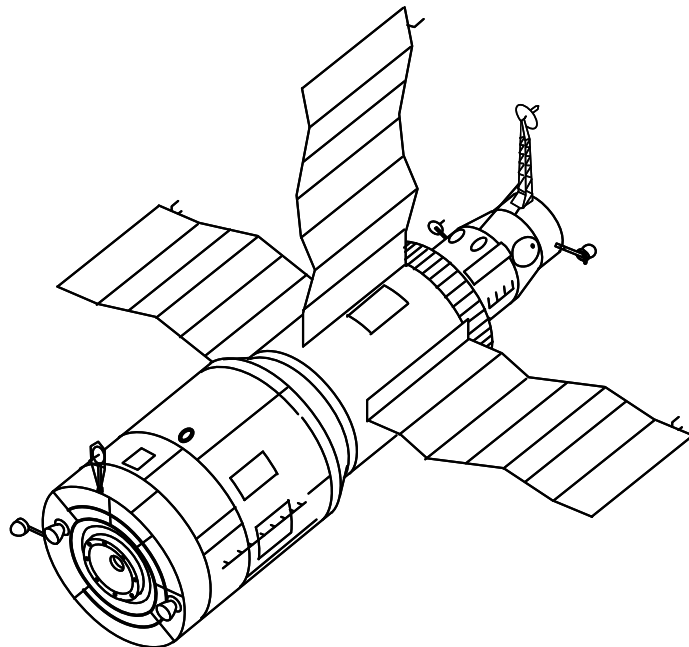

Figure 2-9. Salyut 6, the third DOS station to be manned. Addition of the aft port (left) forced redesign of the main propulsion system.

2.7.1 Salyut 6 Specifications

Length	15.8 m
Maximum diameter	4.15 m
Habitable volume	90 m ³
Weight at launch	19,824 kg
Launch vehicle	Proton (three-stage)
Orbital inclination	51.6°
Span across solar arrays	17 m
Area of solar arrays	51 m ²
Number of solar arrays	3
Electricity available	4-5 kW
Resupply carriers	Soyuz Ferry, Soyuz-T, Progress, TKS
Number of docking ports	2
Total manned missions	18
Total unmanned missions	13
Total long-duration missions	6
Number of main engines	2
Main engine thrust (each)	300 kg

2.7.2 Salyut 6 Notable Features

- Most notable single feature was aft docking port that permitted dockings by Visiting Expeditions and resupply by Progress freighters. Aft port equipped with the Igla approach system. Docking collar contained ports for transfer of propellants and pressurant from a docked Progress to Salyut 6's tanks. The aft port was connected to the large-diameter work compartment through a small intermediate compartment.
- Large-diameter compartment longer than the one on the first-generation Salyut 1 and Salyut 4 stations (6 m vs 4.1 m). Omission of the Soyuz-based propulsion module used on the first-generation stations meant total station length did not change.
- As with the earlier Salyuts, Salyut 6's large-diameter work compartment was dominated by a conical housing for scientific equipment. For Salyut 6 it contained astronomical equipment, including the BST-1M multispectral telescope

and the Yelena gamma-ray telescope.

- Had three sets of large solar arrays—one set on either side of the hull, and one on top. The arrays were equipped with motors and sun-sensors for automatic Sun tracking. Communications antennas were located on the ends of the solar arrays. Radio signals from the antennas and electricity generated by the arrays passed through “rotating connections” at the bases of the arrays to enter Salyut 6. Salyut 4 also had steerable arrays, though their functional details may have differed from those on Salyut 6. There was no fourth array opposite the array on top because it would have interfered with the instruments projecting from the conical scientific instrument compartment, which opened to space on that side (the bottom) of the station.³⁵
- Guidance and control systems concentrated in the Orientation and Motion Control System of the Station (Russian acronym SOUD). It included gyroscopes, ion sensors, solar sensors, star

sensors, a sextant, manual controls, the Kaskad orientation system, and “the radio rendezvous equipment which jointly with the radio equipment of the transport ship provides for measuring the relative parameters of motion.” Rendezvous and docking was the SOUD's most complicated operating mode. The system had several layers of redundancy.³⁶

- Attitude control and main propulsion systems were brought together in Salyut 6 to form the Integrated Propulsion System (Russian acronym ODU). Both attitude control and main propulsion engines drew on the same supply of N₂O₄ and UDMH propellants. The two main engines each had 300 kg of thrust. The 32 attitude control engines each had 14 kg of thrust.³⁷
- To permit changeout and addition of scientific gear, extra electrical outlets for new scientific equipment were provided within Salyut 6's pressurized compartments.

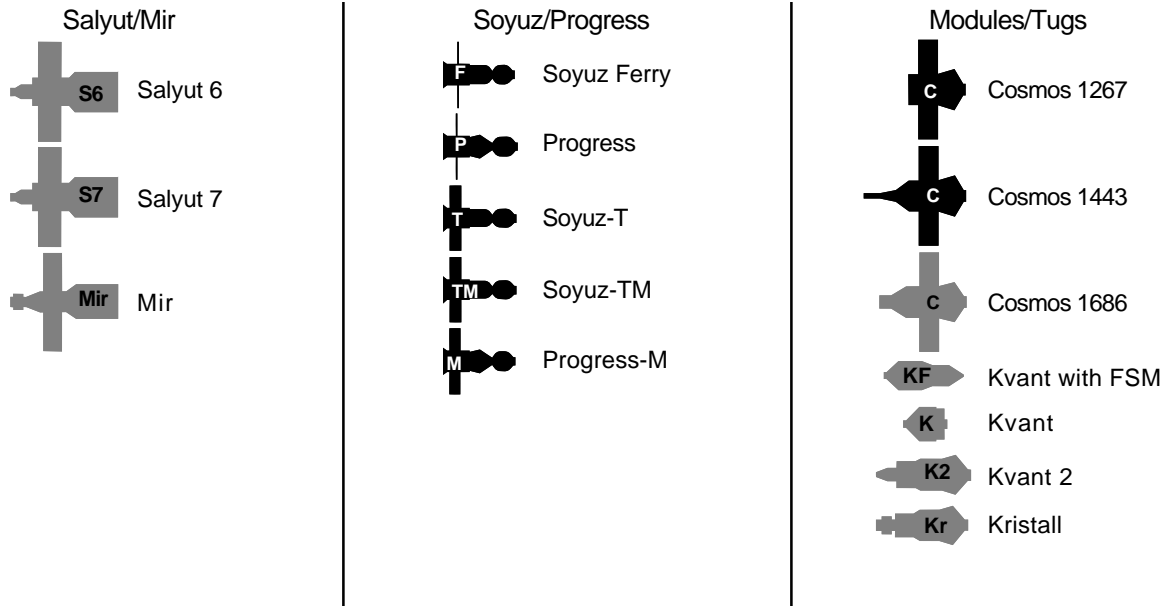
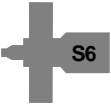



Figure 2-10. Key to icons. Salyut 6 and Salyut 7 each had two docking ports; the Mir base block has two docking ports and four berthing ports. Multiple docking ports mean continual configuration changes as spacecraft come and go and modules are added. The icons shown here are combined in sections 2.7.3, 2.8.3, and 2.9.3 to depict the changing configurations of the three multimodular stations throughout their careers (1977-1994). The icons and icon combinations are strictly representative, and do not depict the true orientation of solar arrays or true relative sizes.

2.7.3 Salyut 6 Career

Changes in the configuration of the Salyut 6 station included dockings by Soyuz Ferry, Soyuz-T, Progress, and the Cosmos 1267 FGB, as well as Soyuz transfers from port to port. The icons on the following pages depict these changes. Aligned horizontally with each icon are names (arranged to match icon positions) of spacecraft and station modules depicted and the inclusive dates of the configuration. Port transfers are shown by flipping the Salyut icon and leaving the Soyuz icon in place because it was Salyut 6 that rotated during port transfers. The text blocks below the icons cover important hardware-related events, such as anomalies and EVAs. Refer to figure 2-10 for key to icons. For more information on Soyuz Ferry, Soyuz-T, and Progress vehicles mentioned, see sections 1.8.4.5, 1.12.3.2, and 1.10.4.2. For Cosmos 1267 FGB information, see section 3.3.4.

	Salyut 6	September 29-October 10, 1977
	Soyuz 25 • Salyut 6	October 10, 1977
	<p>Unsuccessful Soyuz 25 docking. Soyuz 25 achieved soft dock with the new Salyut 6 station, inserting its probe apparatus into the conical drogue of the Salyut 6 front port. Hard docking involved retracting the probe to pull the station and spacecraft docking collars together. However, the docking collars would not latch. Cosmonauts Vladimir Kovalyonok and Valeri Ryumin had to</p>	

return to Earth before their ferry's batteries became depleted. Engineers theorized that the Salyut 6 forward port might have been damaged during ascent, or that the Soyuz 25 docking unit was at fault. If the latter was true (and they could not be certain, because the docking unit was discarded before reentry, along with the Soyuz 25 orbital module), then it was possible that the several hard docking attempts had damaged the Salyut 6 forward port, making it unfit for future dockings.³⁸

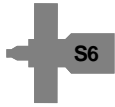

Salyut 6

October 10-December 11, 1977

2.7.3.1 Salyut 6 Principal Expedition 1

Yuri Romanenko, Georgi Grechko

Crew code name—Tamyrs

Launched in **Soyuz 26**, December 10, 1977

Landed in **Soyuz 27**, March 16, 1978

96 days in space

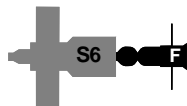

Salyut 6 • Soyuz 26

December 11, 1977-January 11, 1978

Soyuz 26 docks at aft port, EVA inspection of front port. The Tamyrs docked with the station's aft port because of the Soyuz 25 failure. On December 20 they conducted the first EVA from a Salyut space station. They depressurized the forward transfer compartment and opened the forward docking port. Grechko and Romanenko inspected the forward docking port drogue and docking collar. They beamed color TV images of the unit to the TsUP in Moscow. Grechko reported, "All of the docking equipment—lamps, electric sockets, latches—all is in fine order." The spacewalk lasted about 20 min, and depressurization lasted about 90 min. They repressurized the transfer compartment from storage tanks—a procedure first tested by the Soyuz 24 crew on Salyut 5 in February 1977. Their inspection confirmed that the Soyuz 25 spacecraft docking unit was at fault in its failure to hard dock, and that its docking attempts had left the Salyut 6 front port undamaged. During this period, the Tamyrs extensively tested the Salyut 6's Delta automatic navigational system. On December 29 the Soyuz 26 main engine raised Salyut 6's orbit. Because Soyuz 26 was at the aft port, Salyut 6's own engines could not be used to raise its orbit.^{39, 40}

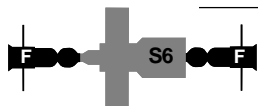

Soyuz 27 • Salyut 6 • Soyuz 26

January 11-16, 1978

Soyuz 27 arrives at Salyut 6. The Soviets hurried to take advantage of the undamaged Salyut 6 forward port. Soyuz 27 docked without incident at the front port carrying cosmonauts Oleg Makarov and Vladimir Dzhanibekov, who formed the first Visiting Expedition crew in the Soviet space station program (or, for that matter, in any space station program). For the docking, the Tamyrs withdrew to their Soyuz 26 spacecraft and sealed the hatch into Salyut 6 behind them. This was done in the event of a depressurization emergency associated with the docking of Soyuz 27. There was also some concern that

stresses and vibrations produced when the 7-ton Soyuz 27 spacecraft contacted the front port might transmit through Salyut 6, forcibly uncoupling Soyuz 26 from the rear port.

Rezonans and first spacecraft swap. The Soyuz 27-Salyut 6-Soyuz 26 combination massed about 33,000 kg and featured seven compartments: two descent modules, two orbital modules, the transfer compartment, the work compartment, and the small aft intermediate compartment. The four cosmonauts conducted many experiments, including Rezonans, which was designed to determine if resonant frequencies might threaten the structural integrity of the three-spacecraft combination. The experiment called for the cosmonauts to jump around Salyut 6 on command from the TsUP. The guest crew spent 5 days on Salyut 6, then returned to Earth in Soyuz 26, leaving the fresh Soyuz 27 spacecraft for the Tamyr. This was the first of many such spacecraft swaps.

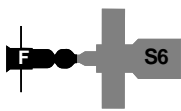

Soyuz 27 • Salyut 6

January 16-22, 1978

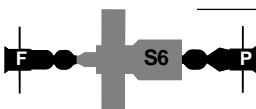

Soyuz 27 • Salyut 6 • Progress 1

January 22-February 6, 1978

Progress 1 refuels Salyut 6. The first Progress delivered what would become the standard manifest of food, air, water, and fuel. According to Sergei Krikalev, in Progress' early days the cosmonauts rushed to unload delivered supplies and reload the Progress with waste. By the time he flew for the first time (to Mir, in 1988), this procedure had been modified to let Progress serve as a kind of storage room while docked. The Progress was retained for as long as possible (until the next Progress was needed and ready for launch), and cargo was removed gradually, as needed. For this purpose, cargo was loaded so that it could be taken out in order of anticipated need. Center-of-gravity and volume limitations sometimes compromised this, however.⁴¹ For this first Progress refueling operation, the Tamyr fastidiously inspected Salyut 6's fuel lines for leaks for several days. Fuel and oxidizer were transferred February 2-3. On February 5 nitrogen from Progress 1 purged the lines so they would not spill toxic propellant onto the docking drogue when the supply ship undocked.



Soyuz 27 • Salyut 6

February 6-March 3, 1978

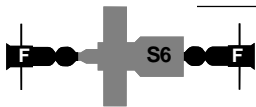

Soyuz 27 • Salyut 6 • Soyuz 28

March 3-10, 1978

First Intercosmos mission. Alexei Gubarev and Vladimir Remek formed the Zenit Visiting Expedition. Vladimir Remek, a Czech, was the first non-U.S./ non-Soviet space traveler. He flew as part of Intercosmos, a program of cooperative space activities between the Soviet Union and other countries (especially those in the eastern bloc). Remek's experiment program touched on life sciences, materials processing, and upper atmosphere research.

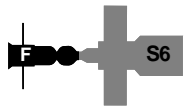

Soyuz 27 • Salyut 6

March 10-16, 1978

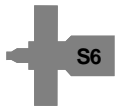

Salyut 6

March 16-June 16, 1978

2.7.3.2 Salyut 6 Principal Expedition 2

Vladimir Kovalyonok, Alexandr Ivanchenkov

Crew code name—Foton

Launched in **Soyuz 29**, June 15, 1978

Landed in **Soyuz 31**, November 2, 1978

140 days in space

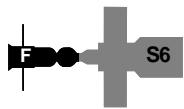

Soyuz 29 • Salyut 6

June 16-29, 1978

The Fotons start work aboard Salyut 6. Upon arriving at Salyut 6, Kovalyonok and Ivanchenkov switched on the station's air regenerators and thermal regulation system, and activated the water recycling system to reprocess water left aboard by the Tamyr. De-mothballing Salyut 6 occurred simultaneously with the crew's adaptation to weightlessness, and required about one week. On June 19 Salyut 6 was in a 368 km by 338 km orbit. Onboard temperature was 20°C, and air pressure was 750 mm/Hg. Soon after this, Kovalyonok and Ivanchenkov performed maintenance on the station's airlock, installed equipment they brought with them in Soyuz 29's orbital module, and tested the station's Kaskad orientation system. The station operated in gravity-gradient stabilized mode June 24-26 to avoid attitude control system engine firings which could cause interference with a 3-day smelting experiment using the Splav-01 furnace. The previous crew installed the furnace in the intermediate compartment so it could operate in vacuum.⁴²

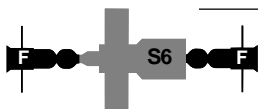

Soyuz 29 • Salyut 6 • Soyuz 30

June 29-July 5, 1978

Poland in space. Mirosław Hermaszewski, the second Intercosmos cosmonaut, flew to Salyut 6 with Pyotr Klimuk. His experiment program stressed life sciences, Earth observations, and study of the aurora borealis.



Soyuz 29 • Salyut 6



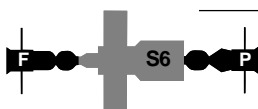



July 5-9, 1978

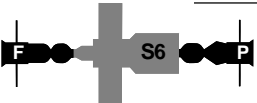

Soyuz 29 • Salyut 6 • Progress 2

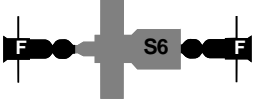
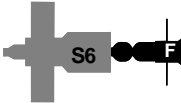
July 9-August 2, 1978

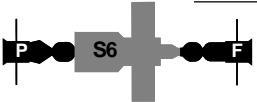
EVA and Progress 2. Progress 2 delivered, among other items, the Kristall kiln. Fuel transfer was carried out under TsUP control, leaving the cosmonauts free to do other things. On July 29, the Fotons conducted an EVA to retrieve detectors and materials samples launched attached to the Salyut 6 hull. The EVA lasted 2 hr, 5 min. Afterwards, the Fotons replenished the Salyut 6 air supply, which had been depleted by the EVA, from tanks in Progress 2. They then filled Progress 2 with trash. It separated and deorbited on command from the TsUP.⁴³

	Soyuz 29 • Salyut 6	August 2-10, 1978
	Soyuz 29 • Salyut 6 • Progress 3	August 10-21, 1978
	Soyuz 29 • Salyut 6	August 21-27, 1978
	Soyuz 29 • Salyut 6 • Soyuz 31	August 27-September 3, 1978
	East Germany in space. Valeri Bykovski and Sigmund Jähn of East Germany formed the Yastreb crew. Jähn's program focused on materials sciences, Earth observations, and life sciences.	
	Salyut 6 • Soyuz 31	September 3-7, 1978
	Salyut 6 • Soyuz 31	September 7-October 6, 1978
	Transfer from aft port to front port. The Fotons conducted the first transfer of a Soyuz from the aft port to the front port of a space station. This became a routine procedure. They undocked Soyuz 31 and backed off to 100-200 m distance. Then the TsUP commanded Salyut 6 to rotate laterally 180°, placing the front port before the waiting Soyuz 31 spacecraft. The operation freed the aft port for additional Progress freighters. ⁴⁴	
	Progress 4 • Salyut 6 • Soyuz 31	October 6-24, 1978
	Salyut 6 • Soyuz 31	October 24-November 2, 1978

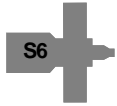
**Salyut 6**

November 2, 1978-February 26, 1979

Salyut 6 propulsion system malfunction. Late in Salyut 6 Principal Expedition 2, the Fotons noted deviations in the control parameters of the fuel lines in the Salyut 6 propulsion system. During this period, analysis of readings from six sensors indicated a leak in one of three tanks in the Salyut 6 ODU. UDMH fuel had leaked into the nitrogen-pressurized bellows which pushed fuel from the tank to Salyut 6's rocket motors. It threatened to damage nonmetallic parts of a valve which lead into the "supercharging line," and to contaminate the entire propulsion system, including the attitude control system.^{45, 46}

2.7.3.3 Salyut 6 Principal Expedition 3

Vladimir Lyakhov, Valeri Ryumin

Crew code name—Proton

Launched in **Soyuz 32**, February 25, 1979Landed in **Soyuz 34**, August 19, 1979

175 days in space

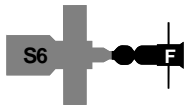
**Salyut 6 • Soyuz 32**

February 26-March 14, 1979

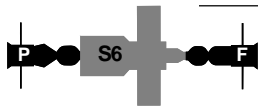
**Progress 5 • Salyut 6 • Soyuz 32**

March 14-April 3, 1979

Propulsion system repair. Repair procedures began on March 15. Fuel in the undamaged tanks was combined in one tank. The station was spun end over end so centrifugal force would separate UDMH fuel from the nitrogen pressurant leaked from behind the ruptured bellows in the damaged fuel tank. The fuel in the damaged tank was then pumped into the emptied good tank and into two tanks in Progress 5. The damaged tank was then sealed off and opened to space for 7 days. On March 23 the tank was closed and filled with nitrogen pressurant, then vented again. This procedure was repeated several times in order to purge the tank of residual fuel traces. In addition, the "supercharging line" was purged. On March 27 the damaged tank was purged once more, filled with nitrogen, then sealed off from the rest of the fuel system, leaving Salyut 6 with two functioning fuel tanks. The opening and closing of valves was carried out by the crew under supervision of the TsUP.⁴⁷ According to Ryumin, the operation "restored the entire system," and "the success of this operation enabled the station to fly several years beyond the end of the program."⁴⁸

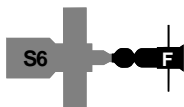
**Salyut 6 • Soyuz 32**

April 3-May 15, 1979

Soyuz 33 malfunction. The Protons were to receive the Saturns, Nikolai Rukavishnikov and Bulgarian Intercosmos cosmonaut Georgi Ivanov, on April 11. But Soyuz 33's main engine failed, forcing its return to Earth without docking with Salyut 6. This cast doubt on Soyuz 32's engine and the engines of other Soyuz Ferries. This in turn cast doubt on the Photons' ability to

complete their mission—Soyuz 32 was nearing the end of its rated 90-day space endurance and needed to be replaced with a fresh craft.⁴⁹ The Saturns returned safely to Earth on April 12 after a ballistic reentry.⁵⁰

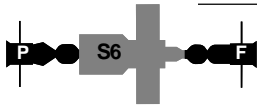

Progress 6 Salyut 6 Soyuz 32

May 15-June 8, 1979

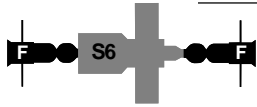

Soyuz 34 • Salyut 6 • Soyuz 32

June 8-13, 1979

Soyuz 34 replaces Soyuz 32. Progress 6 circularized Salyut 6’s orbit on May 29 in preparation for the arrival of Soyuz 34. Soyuz 34 was launched un-manned to replace Soyuz 32, which had exceeded its 90-day stay limit on May 27. Arrival of Progress 34 helped ensure that Ryumin and Lyakhov would be able to complete their mission. Soyuz 34 also tested improvements to the Soyuz main engine meant to prevent recurrence of the Soyuz 33 failure. The spacecraft delivered 200 kg of cargo. Soyuz 32 returned to Earth un-manned with a cargo of experiment results and malfunctioning Salyut 6 equipment. The equipment was of interest to space station engineers.⁵¹

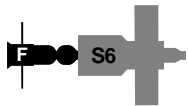

Soyuz 34 • Salyut 6

June 13-14, 1979

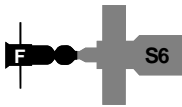

Soyuz 34 • Salyut 6

June 14-30, 1979

Port Transfer. The Soviets transferred Soyuz 34 from the aft port to the front port by rotating Salyut 6. This freed the aft port for Progress 7.

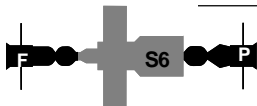

Soyuz 34 • Salyut 6 • Progress 7

June 30-July 18, 1979

KRT-10 assembly and deployment. Progress 7 delivered the 350-kg KRT-10 radio telescope. It comprised a total of seven pieces of equipment: antenna reflector, “focal container and supports,” “mechanism for securing the antenna to the station,” control console, “time block,” and a package containing low-frequency radiometers. The Protons assembled the antenna and its support equipment in the station and Progress 7’s dry cargo compartment over a 2-week period. Ryumin and Lyakhov had not seen the complete system before because the KRT-10 was still being tested and manufactured at the time they were trained to assemble it. Control panels were attached to the conical housing in the large-diameter compartment and data recorders to the station’s “ceiling.” A “cable entrance mechanism” was assembled in the intermediate compartment, behind the device for securing the antenna to the station, which filled the aft port. The diameter of the folded antenna was only 0.5 m. As Progress 7 backed away from the station, Ryumin commanded the antenna to unfold from the aft port. A TV camera on Progress 7 transmitted a blurry image of Salyut 6’s aft port to the TsUP and the TV aboard Salyut 6 as the KRT-10 opened to its full 10-m diameter.^{52, 53, 54}

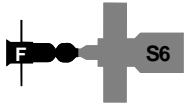
**Soyuz 34 • Salyut 6**

July 18-August 19, 1979

Emergency EVA to remove KRT-10. On August 9 the KRT-10 antenna failed to separate from Salyut 6. Examination through the aft-facing ports indicated that the antenna was snared on the aft docking target. This prevented further Progress dockings and interfered with the engines. The Protons attempted to free the antenna by rocking the station. After considering abandoning Salyut 6—according to Ryumin, its primary mission was complete—crew and TsUP agreed to attempt an EVA to remove the antenna. Ryumin and Lyakhov performed the 83-min EVA on August 15. With difficulty Ryumin deployed a folded handrail, then clambered over the hull to the rear of the station. He found that the KRT-10's ribs had torn the station's insulation. As Ryumin cut cables the KRT-10 oscillated back and forth, threatening to strike him. Ryumin carried a 1.5-m barbed pole to push the antenna away after he finished cutting it away from Salyut 6. Once the antenna was discarded, the Protons inspected the exterior of Salyut 6. They found that portions of its insulation had broken off or become discolored. They also retrieved samples of materials that had been exposed to space conditions on Salyut 6's hull, and a portion of the micrometeoroid detector.^{55, 56}

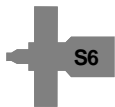
**Salyut 6**

August 19-December 19, 1979

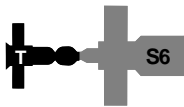
**Soyuz-T 1 • Salyut 6**

December 19, 1979-March 23, 1980

Soyuz-T 1. This improved version of Soyuz was test-flown unmanned to Salyut 6. It remained docked to the unmanned station, powered down, for 95 days, then returned to Earth.^{57, 58}

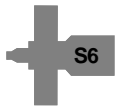
**Salyut 6**

March 23-29, 1980

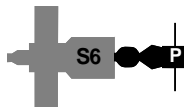
**Salyut 6 • Progress 8**

March 29-April 10, 1980

2.7.3.4 Salyut 6 Principal Expedition 4

Leonid Popov, Valeri Ryumin
Crew code name—Dneiper
Launched in **Soyuz 35**, April 9, 1980
Landed in **Soyuz 37**, October 11, 1980
185 days in space

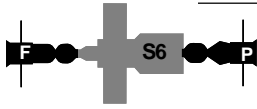

Soyuz 35 • Salyut 6 • Progress 8

April 10-25, 1980

Ryumin again in orbit. Valentin Lebedev was scheduled to be Leonid Popov's flight engineer, but he required an operation after injuring his knee while working out on a trampoline. Ryumin, of the last crew to visit Salyut 6, was called in to fill his place. Upon entering Salyut 6, Ryumin noted that the two viewports in the transfer compartment had lost their transparency. The windows also had many chips in them caused by micrometeoroids and orbital debris.⁵⁹ The cosmonauts replaced components of the attitude control system and life support system, installed a new caution and warning system, synchronized the station's clocks with those in the TsUP, added an 80-kg storage battery, and replaced air from tanks in Progress 8.

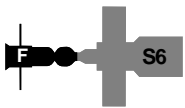

Soyuz 35 • Salyut 6

April 25-29, 1980

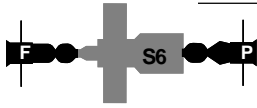

Soyuz 35 • Salyut 6 • Progress 9

April 29-May 20, 1980

Progress 9 pumps water. Before Progress 9, Salyut 6 crewmen had to transfer water into the station in 5-kg containers. Progress 9 featured the Rodnik system, by which crewmen ran a pipe to the station's tanks. The cargo ship transferred 180 kg of water in this manner.

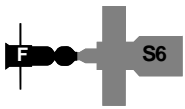

Soyuz 35 • Salyut 6

May 20-27, 1980

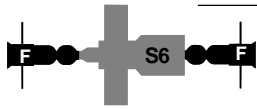

Soyuz 35 • Salyut 6 • Soyuz 36

May 27-June 3, 1980

Hungary in space. Valeri Kubasov and Bertalan Farkas formed the Orion Visiting Expedition crew. Hungary's experiments were in the areas of materials processing, Earth observation, and life sciences.

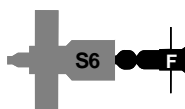

Salyut 6 • Soyuz 36

June 3-4, 1980

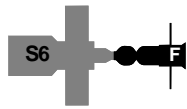

Salyut 6 • Soyuz 36

June 4-6, 1980

Port Transfer. Soyuz 36 was repositioned by rotating Salyut 6, freeing the aft port for Soyuz-T 2.

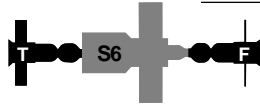

Soyuz-T 2 • Salyut 6 • Soyuz 36

June 6-9, 19

Soyuz-T 2. This was a manned test flight of the successor to the Soyuz Ferry, the Soyuz-T. Cosmonauts Yuri Malyshev and Vladimir Aksyonov spent only 2 days on Salyut 6 with the Dneiper resident crew.

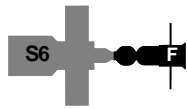

Salyut 6 • Soyuz 36

June 9-July 1, 1980

Running track breaks. Popov and Ryumin relied heavily on the running track and bicycle ergometer to maintain their fitness so they could return safely to Earth after their prolonged stay in weightlessness. On June 15 their running track broke, but the cosmonauts avoided repairing it for several days, because “it meant unscrewing a lot of bolts and would take a lot of time to repair.” However, doctors on the ground ordered them to increase their level of exercise, so they had to repair the track.⁶⁰ Also at about this time, the cosmonauts repaired the Kaskad attitude control system, in the process expending a large amount of fuel.

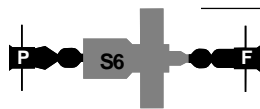

Progress 10 • Salyut 6 • Soyuz 36

July 1-17, 1980

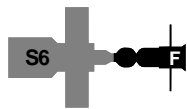

Salyut 6 • Soyuz 36

July 17-24, 1980

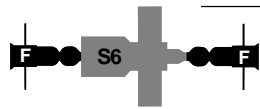

Soyuz 37 • Salyut 6 • Soyuz 36

July 24-31, 1980

Vietnam in space. Viktor Gorbalko and Pham Tuan of Vietnam arrived aboard Salyut 6 in Soyuz 37, and returned to Earth in Soyuz 36. Tuan’s 30 experiments involved observing Vietnam from space, life sciences (including tests of growth of Vietnamese azolla water ferns, with application to future closed-loop life support systems), and materials processing.

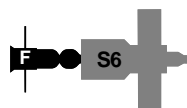

Soyuz 37 • Salyut 6

July 31-August 1, 1980



Soyuz 37 • Salyut 6

August 1-September 19, 1980

Port Transfer. Soyuz 37 was repositioned by rotating Salyut 6, freeing the aft port for Soyuz 38.

Microgravity at night. Ryumin noted in his diary on August 16 that every night before going to sleep the crew activated the Kristall or Splav-01 materials processing furnaces. This was done to reduce the level of disturbance caused by crew movements around the station, improving its microgravity conditions for materials processing.⁶¹ Ryumin also commented that Splav and Kristall could not be used at the same time, because they each placed a heavy load on the Salyut 6 power supply. Previous expeditions had operated the furnaces for a maximum of 10-12 hr at a time, but for Salyut 6 Principal Expedition 4, longer melts, of 120 hr and 60 hr, were carried out. The products of these melts were large crystals.⁶²

Fuel conservation and problems with showers. On September 10 Ryumin wrote in his diary that the experiments requiring that Salyut 6 be maneuvered at a cost in fuel were complete, so the station was in a gravity-gradient stabilization mode at least until the next Progress arrived. In this mode it pointed the aft end of the Soyuz 37 spacecraft toward the Earth. This made Earth observations convenient, as most of the windows not blocked by equipment were located in the transfer compartment and pointed toward Earth. Ryumin also noted that he and Lyakhov had decided to postpone their monthly shower. “When you begin to think of all the preparatory operations you have to do, and then how many post-shower operations you have to perform, the desire to take a shower diminishes. You have to heat the water, in batches, no less. You have to get the shower chamber, set up the water collectors, attach the vacuum cleaner . . . it takes nearly the entire day just for that shower,” he complained.⁶³

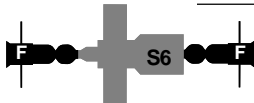

Soyuz 37 • Salyut 6 • Soyuz 38 September 19-26, 1980

Cuban in Space. The Soyuz 38 docking occurred in darkness. As the spacecraft approached Salyut 6, the Dneipers could see only its “headlights.” Ryumin filmed ignition and operation of the transport’s main engine.⁶⁴ Arnaldo Tamayo-Mendez of Cuba and Soviet cosmonaut Yuri Romanenko docked without incident.



Soyuz 37 • Salyut 6 September 26-30, 1980

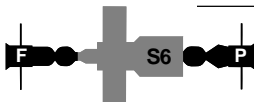

Soyuz 37 • Salyut 6 • Progress 11 September 30-October 11, 1980

Principal Expedition 4 ends. Ryumin reported that his last 10 days on Salyut 6 were very busy. The Dneipers unloaded Progress 11, changed out the station’s communications equipment, and mothballed the station. Ryumin considered the communications gear changeout the most serious repair operation the Dneipers had carried out.

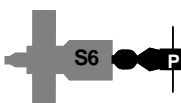

Salyut 6 • Progress 11 October 11-November 28, 1980

2.7.3.5 Salyut 6 Principal Expedition 5

Leonid Kizim, Oleg Makarov, Gennadi Strekalov

Crew code name—Mayak

Soyuz-T 3, November 27-December 10, 1980

13 days in space

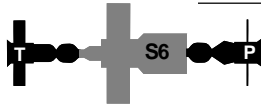

Soyuz-T 3 • Salyut 6 • Progress 11 November 28-December 9, 1980

Experiments and repairs. The Mayaks were the first three-person space station crew since Soyuz 11 in 1971. Part of their mission was to further test the Soyuz-T. During their brief stay on Salyut 6, they performed the usual experiments using the Splay and Kristall units, and studied “biological objects” they brought with them in Soyuz-T 3. They used the Svetoblok and Oasis units. Much of their time, however, was devoted to space station maintenance. On December 2 they commenced conducting the Mikroklimat experiment to assess the station’s living conditions, and began work on the thermal control system. They installed a new hydraulic unit with four pumps. On December 4 they replaced electronics in the Salyut 6 telemetry system. December 5 saw them repairing electrical system faults. Other repairs included replacement of a program and timing device in the onboard control system and replacement of a power supply unit for the compressor in the refueling system. The Salyut 6 Principal Expedition 4 crew in the TsUP provided the crew with advice as they made their repairs. On December 8 Progress 11 carried out an orbit correction for the complex.⁶⁵



Soyuz-T 3 • Salyut 6

December 9-10, 1980

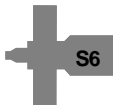

Salyut 6

December 10, 1980-January 26, 1981

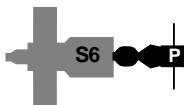

Salyut 6 • Progress 12

January 26-March 13, 1981

2.7.3.6 Salyut 6 Principal Expedition 6

Vladimir Kovalyonok, Viktor Savinykh
 Crew code name—Foton
Soyuz-T 4, March 12-May 26, 1981
 75 days in space

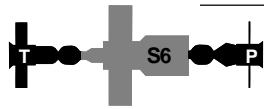
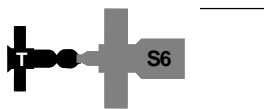
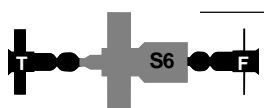
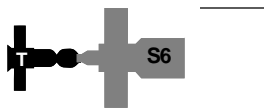
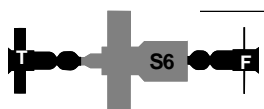
	Soyuz-T 4 • Salyut 6 • Progress 12	March 13-19, 1981
	Soyuz-T 4 • Salyut 6	March 19-23, 1981
	Soyuz-T 4 • Salyut 6 • Soyuz 39	March 23-30, 1981
	<p>Soyuz 39 Intercosmos flight. Soyuz 39 docked with the first Mongolian cosmonaut aboard. The Fotons assisted the Intercosmos crew with station equipment and oriented the station according to the needs of the Visiting Expedition’s experiments. On March 24 the cosmonauts installed cosmic ray detectors in the work and transfer compartments. On March 26 the cosmonauts performed the Illyuminator (“viewing port”) experiment, which studied the degradation of the station’s viewports. On March 27 Kovalyonok and Savinykh used the Gologamma (“hologram”) apparatus to image a viewing port damaged by micrometeoroids. They repeated this March 28, when they also collected samples of the station’s air and microflora and removed the cosmic ray detectors for return to Earth. March 28-29 were largely devoted to studies of Mongolia from space. The Visiting Expedition crew checked out their spacecraft on March 29. The Soviet news service Tass noted that by March 29 Salyut 6 had conducted 20,140 revolutions of Earth.⁶⁶</p>	
	Soyuz-T 4 • Salyut 6	March 30-May 15, 1981
	Soyuz-T 4 • Salyut 6 • Soyuz 40	May 15-22, 1981
	<p>Last Soyuz Ferry docks. Soyuz 40 was the last Soyuz Ferry and the last Soyuz spacecraft to dock with Salyut 6. It also ended the first phase of the Intercosmos program by carrying Romanian cosmonaut Dumitriu Prunariu and Soviet cosmonaut Leonid Popov to the station. Prunariu studied Earth’s magnetic field. Earth observations had to be delayed until the last day of his flight, when Salyut 6 at last passed over Romania in daylight. During this time the crew also tested the station’s orientation system.</p>	

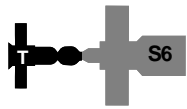

Soyuz-T 4 • Salyut 6

May 22-26, 1981

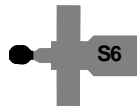

Soyuz-T 4 orbital module • Salyut 6

May 26-31, 1981

Soyuz-T 4 leaves behind orbital module. This procedure was first followed on Soyuz-T 3, though then the module was left attached to the station for only a few hours.

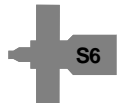

Salyut 6

May 31-June 19, 1981

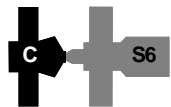

Cosmos 1267 FGB • Salyut 6

June 19, 1981-July 29, 1982

Cosmos 1267 docks. Cosmos 1267 was the FGB component of a TKS vehicle launched on April 25, 1981. Its Merkur capsule had separated and landed in the Soviet Union on May 26.

Salyut 6 held in reserve. Salyut 6's replacement, Salyut 7, was launched on April 19, 1982. Salyut 6 remained in orbit, still docked to Cosmos 1267, at an average altitude of 385 km. The aged laboratory remained in orbit until after the conclusion of the joint Franco-Soviet mission to Salyut 7 (June 24-July 2), then was deorbited using the engines on Cosmos 1267. It may have been kept in orbit as a backup for the Franco-Soviet mission in the event Salyut 7 failed or had its launch delayed.⁶⁷ Sending Chretien to Salyut 7 seems to have represented a change in plans—in 1979, a French publication had quoted Vladimir Shatalov, head of cosmonaut training, as saying that a French cosmonaut would visit Salyut 6. The same publication stated in 1981 that Cosmos 1267 had been scheduled to be undocked from Salyut 6 to make ready for the joint Franco-Soviet crew, but that it was more likely that they would dock with Salyut 7.^{68, 69}

2.8 Salyut 7/DOS-6 (April 19, 1982-February 7, 1991)

2.8.1 Salyut 7 Specifications

Length	about 16 m
Maximum diameter	4.15 m
Habitable volume	90 m ³
Weight at launch	19,824 kg
Launch vehicle	Proton (three-stage)
Orbital inclination	51.6°
Span across solar arrays	17 m
Area of solar arrays	51 m ²
Number of solar arrays	3
Electricity available	4.5 kW
Resupply carriers	Soyuz-T, Progress, TKS
Number of docking ports	2
Total manned missions	12
Total unmanned missions	15
Total long-duration missions	6
Number of main engines	2
Main engine thrust (each)	300 kg

2.8.2 Salyut 7 Notable Features

- In most ways very similar to Salyut 6 (figure 2-9). Below are some differences.
- Living conditions improved over those on Salyut 6. For example, Salyut 7 had hot plates for heating food and continuously available hot water.
- To kill bacteria on the station, two portholes admitted ultraviolet radiation. A large porthole for astronomy was added to the transfer compartment. All portholes were shielded from micrometeoroids by transparent covers when not in use.
- Improved exercise and medical facilities.
- A suite of X-ray detection instruments replaced the BST-1M multispectral telescope.
- Three sets of steerable solar arrays fitted with attachment points for extensions. Extensions would be added as the original arrays degraded in order to keep Salyut 7's electrical supply at a useful level.

2.8.3 Salyut 7 Career

Changes in the configuration of the Salyut 7 station included dockings by Soyuz-T, Progress, the Cosmos 1443 TKS, and the Cosmos 1686 space station module, as well as Soyuz-T transfers from port to port. The icons on the following pages depict these changes. Aligned horizontally with each icon are names (arranged to match icon positions) of spacecraft and station modules depicted and the inclusive dates of the configuration. Port transfers are shown by flipping the Salyut icon and leaving the Soyuz icon in place because it was Salyut 7 that rotated during port transfers. The text blocks below the icons cover important hardware-related events, such as anomalies and EVAs. Refer to figure 2-10 for key to icons. For more information on Soyuz-T and Progress vehicles mentioned, see sections 1.12.3.3, and 1.10.4.3. For more information on the Cosmos 1443 TKS and Cosmos 1686 modified TKS, see sections 3.3.4 and 3.4.

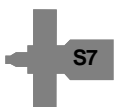

2.8.3.1 Salyut 7 Principal Expedition 1

Anatoli Berezevoi, Valentin Lebedev
 Crew code name—Elbrus
 Launched in **Soyuz-T 5**, May 13, 1982
 Landed in **Soyuz-T 7**, December 10, 1982
 211 days in space

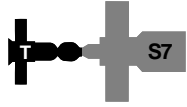

Soyuz-T 5 • Salyut 7

May 14-25, 1982

Launch of Iskra 2. The Elbrus crew ejected a 28-kg amateur radio satellite from a Salyut 7 trash airlock on May 17. The Soviets called this the first launch of a communications satellite from a manned space vehicle. They did this ahead of the launch of two large geostationary satellites from the U.S. Space Shuttle (STS-5, November 11-16, 1982).⁷⁰

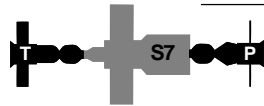

Soyuz-T 5 • Salyut 7 • Progress 13

May 25-June 4, 1982

Violation of Progress docking procedure. The hatch from the work compartment to the intermediate compartment was to be closed when a Progress docked, but Lebedev and Berezevoi wished to watch the approach through an aft-facing porthole in the intermediate compartment. They therefore “clamped the endpoints of the hatch, thus simulating its closure for the TsUP’s benefit.” They forgot to remove the clamps after Progress 13 docked, giving the TsUP an indication that the hatch remained closed even though the Elbrus crew moved back and forth between Progress 13 and Salyut 7. The TsUP gently called them out for this violation of procedure.⁷¹

Unloading Progress 13. On May 25, the Elbrus crew reoriented Salyut 7 so the aft end of the Progress pointed toward Earth. This placed the station in gravity-gradient stabilization. Lebedev remarked in his diary that the attitude control jets were “very noisy,” and that they sounded like “hitting a barrel with a sledgehammer.” Of Salyut 7 during the unpacking of Progress 13, Lebedev said, “It looks like we’re getting ready to move or have just moved to a new apartment.” The following day the Elbrus crew closed the hatch from the work compartment into the intermediate compartment so the TsUP could pump fuel from Progress 13 to Salyut 7. The crew monitored the operation but played little active role in it. May 29 was spent organizing the supplies delivered. At the same time, according to Lebedev, “we filled the resupply ship with what we don’t need and tied them down with ropes. When I enter the resupply ship, it jingles with a metallic sound, so when we separate it will sound like a brass band.” Progress 13 pumped 300 liters of water aboard on May 31. On June 2 Progress 13 lowered the station’s orbit to 300 km to receive Soyuz T-6.⁷²

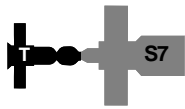

Soyuz-T 5 • Salyut 7

June 4-25, 1982

Taking a shower in space. June 12 was bath day on Salyut 7, the day the Elbrus crew was permitted its first monthly shower. Showering was a complicated process—so much so that the showers, which were expected to be completed by noon, lasted until after 6 p.m. On June 15 Lebedev reported that a brown residue had been deposited between the panes of Salyut 7’s UV-transparent portholes. The residue was apparently produced when UV radiation struck the rubber gasket surrounding the panes.⁷³

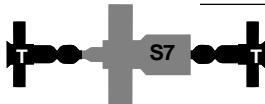

Soyuz-T 5 • Salyut 7 • Soyuz-T 6

June 25-July 2, 1982

Garbage disposal, and the French assessment of Salyut 7. During the stay of the Soyuz-T 6 Visiting Expedition, the Elbrus gave visiting Frenchman Jean-Loup Chretien “the honor” of ejecting a satellite—Salyut 7’s weekly bag of waste—from the small trash airlock. In his diary, Lebedev quoted Chretien as saying Salyut 7 “is simple, doesn’t look impressive, but is reliable.”⁷⁴



Soyuz-T 5 • Salyut 7

July 2-12, 1982

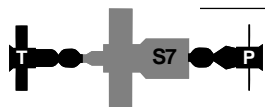

Soyuz-T 5 • Salyut 7 • Progress 14

July 12-August 10, 1982

Plumbing problems. In his July 15 diary entry, Lebedev described how he woke in the middle of the night to urinate, only to find that the toilet (ASU system) overflow light was on. “If we were home, we could go outside,” he wrote. But that’s not a viable option up here, so I had to hold it for a whole hour while I pumped the urine out of the ASU.” Lebedev had other problems with the water system later in the day: for a time he believed he had pumped waste water into the fresh water, spoiling the entire 500 liter supply.⁷⁵

Debris in the air and cleaning Salyut 7. In his diary for July 23, Lebedev described how dust, trash, food crumbs, and droplets of juice, coffee, and tea floated in Salyut 7’s air. Most eventually ended up on the cheesecloth which covered the intake grills of the station’s air circulation fans. He said that the crew periodically disposed of these and replaced them with new ones. He also described a “wet cleaning” of Salyut 7. Once a week the crew used wet napkins soaked with katamine (a scouring detergent) to wipe the panels, handrails, hatches, control panel surfaces, and table. They also opened the wall panels and vacuumed the cable bundles, pipes, and fan grills.⁷⁶

EVA—space construction experiments. On July 30, after more than a week of preparation, Lebedev and Berezevoi conducted a 2.5 hr EVA. Opening the hatch from the transfer compartment to the station hull produced a outgust of lost screws and bolts, dust, and a pencil. Lebedev first installed a movie camera and a floodlight. Then he replaced samples on the Etalon space exposure experiment, a checkerboard of different materials. He deployed and attached himself to the Yakor foot restraint platform. Once there, he spent

considerable time looking at the Earth and inspecting the station. Lebedev was impressed by how still and silent the station's exterior seemed, given its complex and noisy interior mechanisms. He noted that the green insulation on Salyut 7 had already faded and become grayish, but was otherwise undamaged. He also noted two folded Yakor foot restraints and a cable winch near the base of one of the solar arrays. Part of the purpose of his EVA was to perform assembly and disassembly tasks to allow him to judge the feasibility of the next crew using these to put in place solar array extensions. Then the Elbrus replaced the micrometeoroid, Medusa biopolymer, and Elast thermo-insulation samples panels. Lebedev worked with the Istok panel, which tested his ability to turn bolts using a special wrench. When the station moved into sunlight, Lebedev could feel through his gloves that the EVA handrails became hot. The cosmonauts installed additional experiments before returning to the transfer compartment. After the EVA they spent a day storing their space suits. Lebedev found a 20-mm dent in his helmet, with a small split in the metal, possibly produced by striking it on apparatus in the transfer compartment. "Thank God the helmet is built with double layers of metal," he wrote in his diary.^{77, 78}

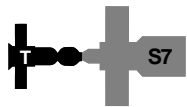

Soyuz-T 5 • Salyut 7

August 10-20, 1982

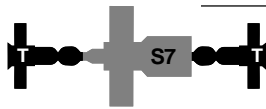

Soyuz-T 5 • Salyut 7 • Soyuz-T 7

August 20-27, 1982

Soyuz-T 7 Visiting Expedition. The Soyuz-T 7 crew (code name Dneiper) included Svetlana Savitskaya, the first woman to visit space in 20 years. She was given the orbital module of Soyuz-T 7 for privacy. The Soyuz-T 7 crew delivered experiments and mail from home to the Elbrus crew. On August 21 the five cosmonauts traded seat liners between the Soyuz-Ts. The Dneipers undocked in Soyuz-T 5, leaving the newer Soyuz-T 7 spacecraft for the long-duration crew.⁷⁹

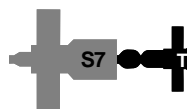

Salyut 7 • Soyuz-T 7

August 27-29, 1982

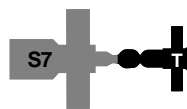

Salyut 7 • Soyuz-T 7

August 29-September 20, 1982

Port Transfer. Soyuz-T 7 was repositioned by rotating Salyut 7, freeing the aft port for Progress 15.

Salyut 7 is home. On September 1 Lebedev concluded his diary entry:

I look around the station and view it with a different attitude. Now I think of it as home. The whole place looks so familiar. Everything in it is so near and dear to me now. When I look at the interior of the station, I feel no alienation, no sense that my surroundings are temporary or strange. Everything is ours. We've touched every square millimeter and object in here. We know exactly where every piece of equipment is mounted, not from documentation but from memory. Many little details, such as photographs on the panels, children's drawings, flowers,

and green plants in the garden [the Oasis, Fiton, and other plant growth units], turn this high-tech complex into our warm and comfortable, if a little bit unusual, home.⁸⁰

Emergency drills. On September 7 the cosmonauts practiced procedures which would come into play in the event of a depressurization of the station. The cosmonauts used a pressure measurement device called Diusa to calculate the time until the station's pressure dropped to 500 mm/Hg. This would tell them how long they had to deactivate the station, gather experiment results and records, put on spacesuits, and enter their Soyuz-T. According to Lebedev's diary, the most dangerous evacuation scenarios were those allowing 5 min or less for an escape. "In such a situation the station could not be saved," he wrote. He also described a scenario in which their Soyuz-T suffered a leak (they would close the hatch leading into the damaged craft and await a rescue ship). According to Lebedev, "we have permission for an emergency landing anywhere on Earth, although we would certainly do everything to land on Soviet territory, or at least on the ground." Specific contingency landing areas are the U.S. Midwest (90°-105° W, 42°-49° N), southern France, and the Sea of Okhotsk.⁸¹ A bag containing experiment results was always kept near the Soyuz-T. According to Lebedev, a pressure drop requiring an hour to reach the critical level would give the crew time to locate and repair the leak. This would be done by sealing off the different compartments until the damaged one was identified. In the event of a fire, the crew would turn off all electrical equipment, put on protective suits and respirators, and use a fire extinguisher.⁸²

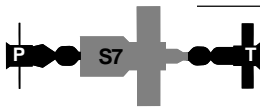

Progress 15 • Salyut 7 • Soyuz-T 7 September 20-October 14, 1982



Salyut 7 • Soyuz-T 7 October 14-November 2, 1982

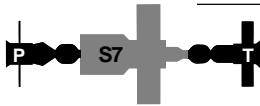

Progress 16 • Salyut 7 • Soyuz-T 7 November 2-December 10, 1982

Iskra 3. Progress 16 delivered the Iskra 3 satellite. It was deployed from the trash airlock on November 18.

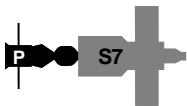

Progress 16 • Salyut 7 December 10-13, 1982

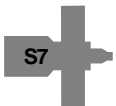

Salyut 7 December 13, 1982-March 10, 1983



Salyut 7 • Cosmos 1443 March 10-June 28, 1983

Cosmos 1443 docks. The third TKS vehicle was launched on March 2. After docking, the Cosmos 1443 propulsion system was used to lower the average orbit of the combination below 300 km.

Soyuz-T 8 failure. The Soviets attempted to man Salyut 7 with the three-person crew of Soyuz-T 8 on April 21. However, the Soyuz Igla approach system antenna was damaged during ascent. The crew attempted a manual docking, but were forced to call it off and return to Earth. Further attempts to man Salyut 7 could not take place for 2 months because of launch and abort lighting constraints.⁸³

2.8.3.2 Salyut 7 Principal Expedition 2

Vladimir Lyakhov and Alexandr Alexandrov

Crew code name—Proton

Soyuz-T 9, June 27-November 23, 1983

149 days in space

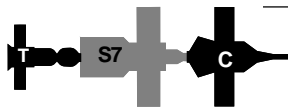

Soyuz-T 9 • Salyut 7 • Cosmos 1443

June 28-August 14, 1983

Protons unload Cosmos 1443. Almost immediately after docking at Salyut 7's aft port, the Protons entered Cosmos 1443 and commenced transferring the 3.5 tons of cargo lining its walls to Salyut 7.

Window impact. On July 27 a small object struck a Salyut 7 viewport. It blasted out a 4-mm crater, but did not penetrate the outer of the window's two panes. The Soviets believed it was a member of the Delta Aquarid meteor shower, though it may have been a small piece of orbital debris.⁸⁴

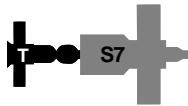

Soyuz-T 9 • Salyut 7

August 14-16, 1983

Casting off Cosmos 1443. The Protons loaded Cosmos 1443's Merkur capsule with 350 kg of experiment results and hardware no longer in use. It could have held 500 kg, had they had that much to put in. Cosmos 1443 then undocked, in spite of Western predictions that the FGB component would remain attached to Salyut 7 as a space station module. The Merkur capsule soft-landed on August 23, and the FGB component continued in orbit until it was deorbited over the Pacific Ocean on September 19.⁸⁵



Soyuz-T 9 • Salyut 7

August 16-19, 1983

Port Transfer. Soyuz-T 9 was repositioned by rotating Salyut 7, freeing the aft port for Progress 17.

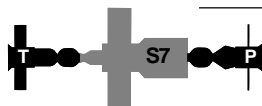

Soyuz-T 9 • Salyut 7 • Progress 17

August 19-September 17, 1983

Salyut 7 propulsion system failure. During refueling by Progress 17, the main oxidizer line of the Salyut 7 propulsion system ruptured. The seriousness of the malfunction was not immediately apparent in the West. However, after the malfunction, Salyut 7 had to rely on the main propulsion systems of visiting Progress freighters for maintaining orbital altitude.

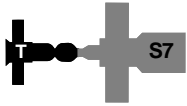

Soyuz-T 9 • Salyut 7

September 17-October 22, 1983

Soyuz rocket launch failure. The Protons expected visitors in late September. On September 26 a Soyuz spacecraft bearing Vladimir Titov and Gennadi Strekalov stood atop a Soyuz booster at Baikonur Cosmodrome. About 90 sec before planned launch time, the booster caught fire. Titov and Strekalov, who had been unable to dock with Salyut 7 on the Soyuz-T 8 mission, were plucked free of the booster, which subsequently exploded.⁸⁶

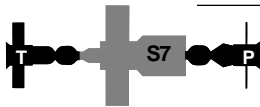

Soyuz-T 9 • Salyut 7 • Progress 18

October 22-November 13, 1983

First and second EVAs—solar array augmentations. During his EVA of July 30, 1982, Valentin Lebedev tested space assembly and disassembly techniques to pave the way for the augmentation of Salyut 7’s solar arrays. The station was designed to have its arrays augmented as their efficiency gradually diminished. The actual installation of the augmentation panels was to be done by “the new crew on the next mission.”⁸⁷ The arrays were delivered by Cosmos 1443. However, the next mission, the three-person Soyuz-T 8, was unable to dock. The Protons docked with Salyut 7 in Soyuz-T 9, and removed the panels from Cosmos 1443 before casting it off. Soyuz-T 8 crewmen Titov and Strekalov, who were trained for the panel augmentation EVA, were then grounded by the September 26 Soyuz booster explosion. It was up to Lyakhov and Alexandrov to carry out the much-delayed augmentation EVAs. They used two Yakor foot restraints installed on Salyut 7 near the base of the solar array. Their first EVA, on November 1, lasted 2 hr, 49 min. The cosmonauts added a new panel to one edge of Salyut 7’s top (center) array. The second EVA, on November 3, was a repeat of the first. It lasted 2 hr, 55 min. Together the two new panels increased Salyut 7’s available electricity by 50%. The Protons replaced air lost through the EVAs from tanks in Progress 18 before casting it off.^{88, 89} Progress 18’s main engine raised Salyut 7’s altitude to 356 km by 326 km on November 4.



Soyuz-T 9 • Salyut 7

November 13-23, 1983

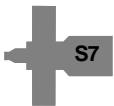

Salyut 7

November 23, 1983-February 9, 1984

2.8.3.3 Salyut 7 Principal Expedition 3

Leonid Kizim, Vladimir Solovyov, Oleg Atkov

Crew code name—Mayak

Launched in **Soyuz-T 10**, February 8, 1984

Landed in **Soyuz-T 11**, October 2, 1984

237 days in space

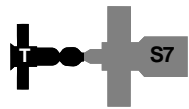

Soyuz-T 10 • Salyut 7

February 9-22, 1984

Mayaks arrive. The three-person Mayak crew entered the darkened Salyut 7 station carrying flashlights. The cosmonauts commented on the burnt-metal odor of the drogue docking unit. By February 17, Salyut 7 was fully reactivated, and the cosmonauts had settled into a routine. Physician Oleg Atkov did household chores and monitored his own health and that of his colleagues, who conducted experiments.

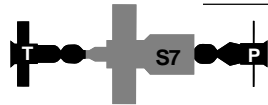

Soyuz-T 10 • Salyut 7 • Progress 19

February 22-March 31, 1984

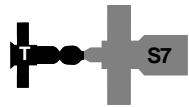

Soyuz-T 10 • Salyut 7

March 31-April 4, 1984

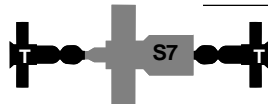

Soyuz-T 10 • Salyut 7 • Soyuz-T 11

April 4-11, 1984

Indian cosmonaut. Rakesh Sharma conducted an Earth observation program concentrating on India. He also did life sciences and materials processing experiments.

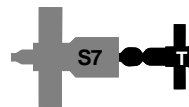

Salyut 7 • Soyuz-T 11

April 11-13, 1984



Salyut 7 • Soyuz-T 11

April 13-17, 1984

Port Transfer. Soyuz-T 11 was repositioned to the front port by rotating Salyut 7, freeing the aft port for Progress 20.

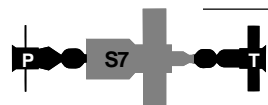





Progress 20 • Salyut 7 • Soyuz-T 11

April 17-May 6, 1984

First, second, third, and fourth EVAs—first phase of Salyut 7 propulsion system repair. The propulsion systems of Progress spacecraft filled in for the Salyut 7 propulsion system after its main oxidizer line ruptured in September 1983. Progress 20 delivered a special ladder for reaching the area of the damaged line. In addition, before launch the exterior of Progress 20's orbital

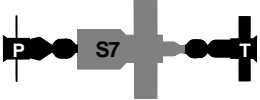
module was fitted with a special extension with foot restraints, as well as with containers for 25 special tools. Kizim and Solovyov spent 4 hr, 15 min outside Salyut 7 on April 23. They attached the ladder and prepared the repair site. On April 26 the cosmonauts cut through thermal insulation and the station's hull to reach the damaged plumbing. They installed a valve in the reserve propellant line before going back inside Salyut 7. The second EVA lasted about 5 hr. On April 29 they again returned to the repair site. They installed a new propellant line to bypass the damaged section in 2 hr, 45 min. During a fourth EVA, on May 4, Kizim and Solovyov installed a second bypass line and covered the opening in Salyut 7's side with thermal insulation. However, they were unable to complete repairs because they lacked tools to close the bypassed propellant line. The fourth EVA lasted 2 hr, 45 min.⁹⁰

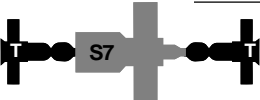
	Salyut 7 • Soyuz-T 11	May 6-10, 1984
	Progress 21 • Salyut 7 • Soyuz-T 11	May 10-26, 1984
	Fifth EVA—second solar array augmentation. Progress 21 delivered two 9 m ² solar array extensions, similar to those added by the Salyut 7 Principal Expedition 2 crew. Solovyov and Kizim added them in an EVA May 19 which lasted over 3 hr. During the EVA, Atkov remained inside Salyut 7. He rotated the array 180° to bring its other edge within reach of the spacewalkers, permitting them to attach the second panel without having to move their foot restraints and equipment. The handle used to operate the winch for raising the array broke, but the cosmonauts were able to complete the operation.	
	Salyut 7 • Soyuz-T 11	May 26-30, 1984
	Progress 22 • Salyut 7 • Soyuz-T 11	May 30-July 15, 1984
	Salyut 7 • Soyuz-T 11	July 15-18, 1984
	Soyuz-T 12 • Salyut 7 • Soyuz-T 11	July 18-29, 1984
	Soyuz-T 12. The Pamirs, the second Visiting Expedition to visit the Mayaks, included veteran cosmonaut Vladimir Dzhanibekov, Buran shuttle program cosmonaut Igor Volk, and Svetlana Savitskaya. On July 25 Dzhanibekov and Savitskaya performed a 3 hr, 30 min EVA, during which they tested the URI multipurpose tool. They cut, welded, soldered, and coated metal samples. During the Pamirs' stay, the six cosmonauts aboard Salyut 7 also conducted Rezonans tests and collected station air samples.	

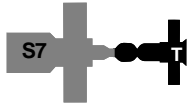
**Salyut 7 • Soyuz-T 11**

July 29-August 16, 1984

Sixth EVA—propellant system repair completed. Soyuz-T 12 delivered a pneumatic hand press. The tool was used during an August 8 EVA to crush both ends of the bypassed fuel line, sealing it. Solovyov and Kizim also collected a piece of a solar array for analysis. In spite of the repair, Salyut 7's main propulsion system was not used again to boost the station's orbit.

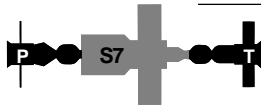
**Progress 23 • Salyut 7 • Soyuz-T 11**

August 16-26, 1984

**Salyut 7 • Soyuz-T 11**

August 26-October 2, 1984

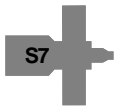
**Salyut 7**

October 2, 1984-June 8, 1985

Salyut 7 comatose. In February the Salyut 7 space station abruptly ceased communicating with the TsUP. On March 2 the Soviet newspaper Pravda printed the following announcement:

In view of the fact that the planned program of work on Salyut 7 has been fulfilled completely, at the present time the station has been deactivated and is continuing its flight in automatic mode.⁹¹

2.8.3.4 Salyut 7 Principal Expedition 4

Vladimir Dzhanibekov, Viktor Savinykh
 Crew code name—Pamir
Soyuz-T 13, June 6-September 26, 1985
 112 days in space

Savinykh remained aboard Salyut 7 when Dzhanibekov departed in Soyuz-T 13.

**Salyut 7 • Soyuz-T 13**

June 8-23, 1985

Salyut 7 revived. The March 2 announcement notwithstanding, by the end of March the Soviets resolved to attempt a Salyut 7 rescue. The effort turned out to be one of the most impressive feats of in-space repairs in history. As the Pamirs approached the inert station, they saw that its solar arrays were pointing randomly as it rolled slowly about its long axis. They used a handheld laser range finder to judge their distance, and conducted a fly-around inspection to be certain the exterior was intact. Dzhanibekov noted that the thermal blankets on the transfer compartment had turned a dull gray from prolonged exposure to sunlight. Upon achieving hard dock—the first time a Soyuz docked with an inactive station—the crew confirmed through the electrical connectors in the docking collars that the Salyut 7 electrical system was dead. They carefully sampled the air in the station before opening the hatch. The station air was

very cold, but breathable. Frost covered the walls and apparatus. The cosmonauts wore winter garb, including fur-lined hats, as they entered the station. The first order of business was to restore electric power. Of the eight batteries, all were dead, and two were destroyed. Dzhaniybekov determined that a sensor had failed in the solar array pointing system, preventing the batteries from recharging. A telemetry radio problem prevented the TsUP from detecting the problem. Salyut 7 had quickly run down its batteries, shutting down all its systems and accounting for the break in radio contact. The cosmonauts set about recharging the batteries. They used Soyuz-T 13 to turn the station to put its solar arrays in sunlight. On June 10 they turned on the air heaters. The cosmonauts relied on the Soyuz-T 13 air regeneration system until they could get the Salyut 7 system back in order. On June 13 the attitude control system was successfully reactivated. This was cause for jubilation, as it meant a Progress bearing replacement parts could dock with Salyut 7. Wall heaters were turned on only after all the frost had evaporated, in order to prevent water from entering equipment. Normal atmospheric humidity was achieved only at the end of July. The station's water tanks thawed by the end of June. Freezing destroyed the water heater, so the cosmonauts used a powerful television light to heat fluids.⁹²

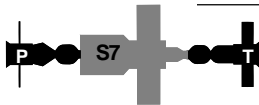

Progress 24 • Salyut 7 • Soyuz-T 13 June 23-July 15, 1985

Progress 24. The freighter delivered propellant, solar array extensions, a new water heater, three new batteries, and about 40 kg of other replacement parts.



Salyut 7 • Soyuz-T 13 July 15-21, 1985

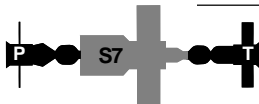

Cosmos 1669 • Salyut 7 • Soyuz-T 13 July 21-August 29, 1985

Cosmos 1669. During its flight, the Soviets claimed Progress 1669 was a freeflyer prototype. Now it is known that the spacecraft was a Progress incorporating upgrades for use with Mir.

EVA—third solar array augmentation. On August 2 the Pamirs stepped outside to add the third and final pair of solar array add-ons to Salyut 7. They wore new semirigid suits delivered by Progress 24. The EVA duration was about 5 hr.



Salyut 7 • Soyuz-T 13 August 29-September 18, 1985

2.8.3.5 Salyut 7 Principal Expedition 5

Vladimir Vasyutin, Viktor Savinykh, Alexandr Volkov

Crew code name—Cheget

Soyuz-T 14, September 17-November 21, 1985

65 days in space

Savinykh returned with Vasyutin and Volkov in Soyuz-T 14. Savinykh's total time in space (Principal Expedition 4 and Principal Expedition 5) was 177 days.

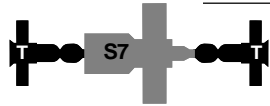

Soyuz-T 14 • Salyut 7 • Soyuz-T 13

September 18-25, 1985

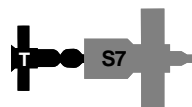

Soyuz-T 14 • Salyut 7

September 25-October 2, 1985

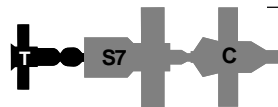

Soyuz-T 14 • Salyut 7 • Cosmos 1686 October 2-November 21, 1985

Cosmos 1686. The main goals of the Chegets were to receive Cosmos 1686, a modified TKS, and conduct spacewalks with application to future space stations. The first goal was achieved on October 2. Cosmos 1686 contained 4500 kg of freight, including large items like a girder to be assembled outside Salyut 7, and the Kristallizator materials processing apparatus.

Vasyutin ill. However, the Chegets were unable to achieve their second goal. By late October Vasyutin was no longer helping with experiments because he was ill. On November 13 the cosmonauts began scrambling their communications with the TsUP. Return to Earth occurred soon after.



Salyut 7 • Cosmos 1686

November 21, 1985-May 6, 1986

2.8.3.6 Salyut 7 Principal Expedition 6

Leonid Kizim, Vladimir Solovyov

Crew code name—Mayak

Soyuz-T 15, Arrived from Mir – May 6, 1986; Departed for Mir – June 25, 1986.

51 days on Salyut 7

See Mir Principal Expedition 1 note.

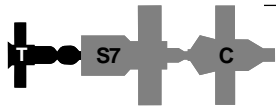

Soyuz-T 15 • Salyut 7 • Cosmos 1686

May 6-June 25, 1986

First EVA—girder experiment. Vasyutin's illness left loose ends on Salyut 7. Most notably, the Chegets were unable to perform EVAs with implications for the Mir program. On May 28 the Mayaks climbed outside to retrieve space exposure experiments and test the Ferma-Postroital ("girder-constructor") device. A deployment canister converted a folded girder cartridge into a 15-m girder in only a few minutes. The girder was retracted by reversing the process at the end of the EVA. The EVA lasted 3 hr, 50 min.

Second EVA—girder and welding experiments. On May 31 Kizim and Solovyov attached measurement devices to the top of the retracted girder, then re-extended it with an aim toward studying its rigidity. They then used an electron gun to weld several of the girder's joints. The EVA lasted 5 hr.



Salyut 7 • Cosmos 1686

June 25, 1986-February 7, 1991

Salyut 7 abandoned; reenters after 4 years. The Mayaks removed 20 instruments with a total mass of 350-400 kg from Salyut 7 before returning to Mir. Between August 19 and August 22, engines on Cosmos 1686 boosted Salyut 7 to a record-high mean orbital altitude of 475 km to forestall reentry. Atmospheric drag took its toll, however, and the station reentered over South America 54 mo later. Pieces of Salyut 7 and Cosmos 1686 were found in Argentina.

2.9 Mir/DOS-7 (February 19, 1986-present)

The Mir space station is the centerpiece of the Russian manned space program. Its base block (figure 2-11) has been in orbit for 9 years.

Continual modifications have more than tripled Mir's original mass and increased its capabilities (figure 2-12) beyond those of any previous space station.

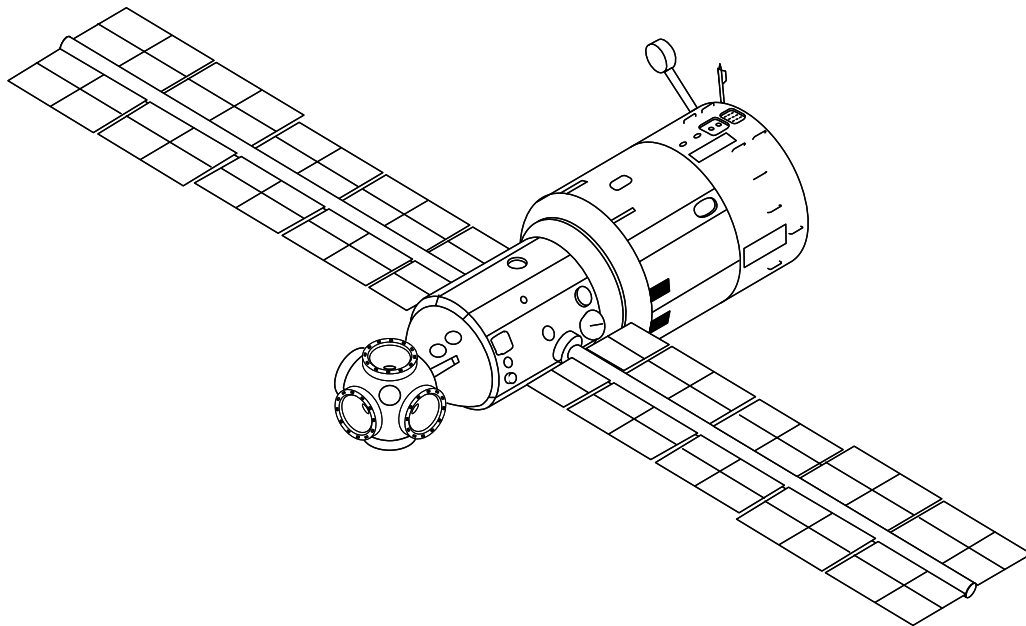

Figure 2-11. Mir base block. The multiport node at the station's forward end (left) has one longitudinal docking port and four lateral berthing ports.

2.9.1 Mir Specifications

Mir base block	
Length	13.13 m
Maximum diameter	4.15 m
Habitable volume	90 m ³
Weight at launch	20,400 kg
Launch vehicle	Proton (three-stage)
Orbital inclination	51.6°
Number of solar arrays	2 (3rd added by EVA)
Span across solar arrays	29.73 m
Area of solar arrays	76 m ² (98 sq/m w/third array)
Electricity available	9-10 kW at 28.6 v
Resupply carriers	Progress, Progress M
Number of docking/berthing ports	2 docking; 4 berthing
Number of main engines	2
Main engine thrust (each)	300 kg

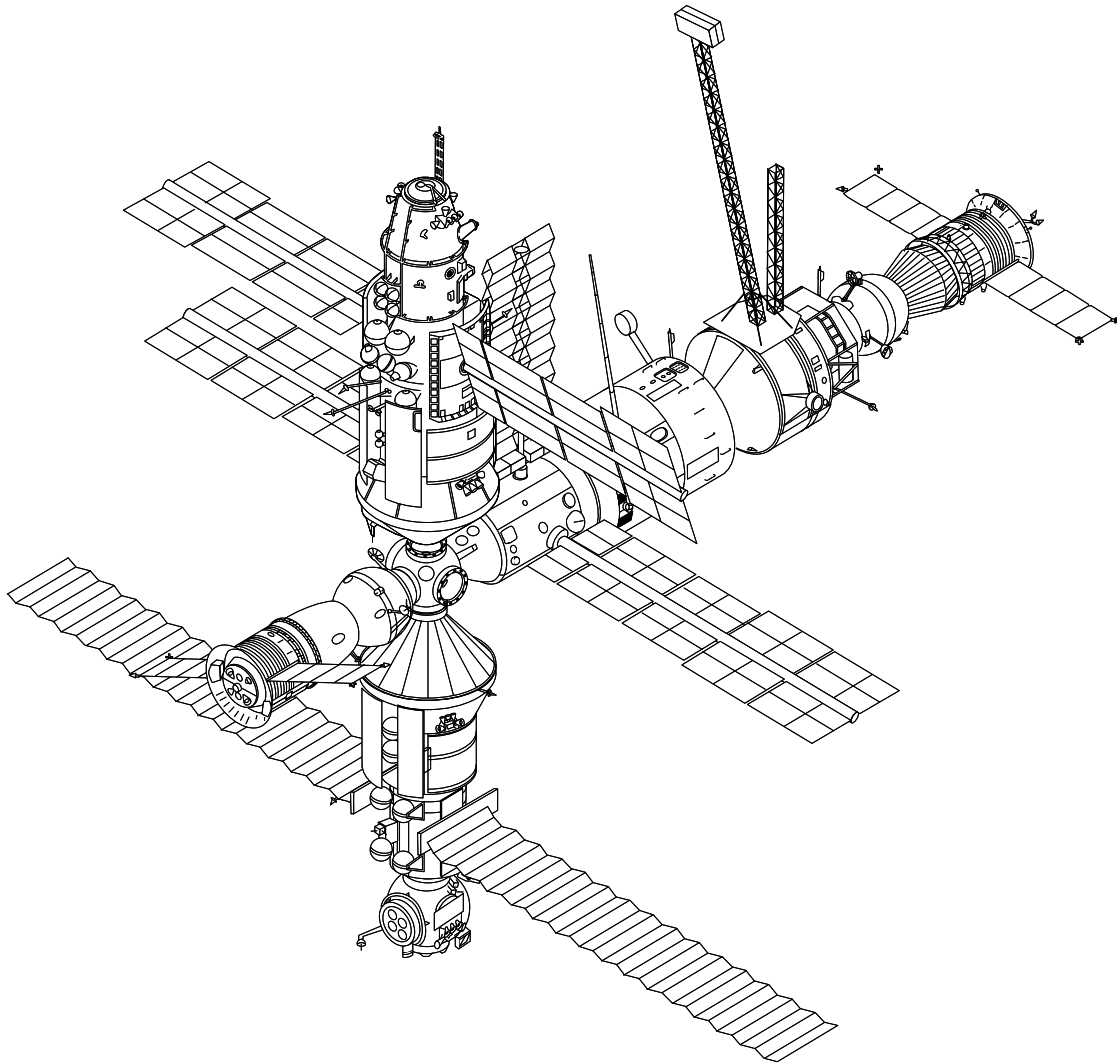

Figure 2-12. The Mir complex as of June 1994, with docked Progress-M 23 (right) and Soyuz-TM 18 (left) spacecraft.

Mir complex (Mir base block—Kvant, Kvant 2, and Kristall) with docked Soyuz-TM and Progress-M spacecraft (as of November 15, 1994)

Length	33 m
Maximum span across habitable modules	~28 m
Maximum diameter of habitable modules	4.35 m
Habitable volume	372 m ³
Weight	93,649 kg
Orbital inclination	51.6°
Number of solar arrays	11
Area of solar arrays	224 m ²
Span across solar arrays	29.73 m
Electricity available (theoretical maximum)	~27.8 kW
Number of docking/berthing ports	4 docking*; 4 berthing**
Total manned missions	20
Total long-duration missions	17

*Two of the docking ports are of APAS-89 androgynous design; two are standard Soyuz drogue units. The drogue ports are longitudinal. One is located on the Mir base block and another is at the aft of the Kvant module. The two APAS-89 ports are attached to the node on the lateral end of the Kristall module.

**Two of the four berthing ports (that is, the lateral ports on the Mir base block) are occupied by the Kvant 2 and Kristall modules. However, the two occupied ports can still be freed for use by moving the berthed modules to another lateral berthing port with their Lyappa arms. The existing modules will be shuffled when the Spektr and Priroda modules are added to Mir.

2.9.2 Mir Base Block Detailed Description and Notable Features

The conical transfer compartment at the front of the DOS-type Salyut stations is replaced by a five-port docking and berthing node. Four ports are lateral, with their docking planes parallel to the station's long axis. They are used to berth modules which have docked at the fifth, longitudinal port (the front port). There is no EVA hatch on the Mir base block, though before the arrival of Kvant 2 and Kristall the cosmonauts could egress through any of the five ports. The node is shorter than the Salyut 7 transfer compartment, accounting for Mir's shorter overall length.

The sixth docking port is located at the aft end of the base block. It closely resembles the aft ports on

Salyut 6 and Salyut 7. It is notable because it has been occupied by the Kvant module since April 1987. Electrical connectors and ports for gas and fluids transfers which permitted Progress to service Mir prior to Kvant's arrival now link Kvant and the Mir base block. Progress vehicles now dock with the aft port on Kvant and transfer fluids and gases through the module to the Mir base block through these ports.

The forward longitudinal port of the Mir base block is equipped with ducts for transferring propellant and water from Progress-M supply ships.

Gallium arsenide solar arrays produce a 30% increase in power density over Salyut 7's silicon arrays (to 120 W/m²). The Soviets conducted many gallium arsenide experiments since 1978 on Salyut 6 and Salyut 7. Mir's arrays have

nearly twice the span of Salyut 7's arrays. Mir was launched with a fixture on top of its small-diameter pressurized compartment for attachment of an auxiliary solar array.

Mir was designed to be used with the Soviet Altair/SR geosynchronous voice and data relay satellites (figure 2-13). These are satellites operated under the ubiquitous Cosmos designation. The satellite system is sometimes designated SDRN (Satellite Data Relay Network) or Luch. A large antenna for radio communications with the Altair/SR system extends from the aft end of Mir.

Although most Mir trash is disposed of in the cargo compartments of Progress freighters, Mir, like its DOS-type Salyut predecessors, has a small airlock which can be used for

trash disposal. It is also used for scientific experiments requiring access to vacuum.

Sergei Krikalev, who flew on the Space Shuttle Atlantis in February 1994 and spent two long-duration stints aboard Mir, made several statements comparing conditions on the U.S. Shuttle with those on Mir. In general, Krikalev states that living conditions aboard Mir are more hospitable than those on the Shuttle. This he attributes to Mir's being designed for long-duration flight, while the Shuttle is designed to support a crew for only short periods of time.⁹³

Long stays in space also affect training and timeline preparation for Mir crews. Mir crews experience more "on-the-job-training" than Shuttle crews, because it is impossible to simulate a 6-month or 12-month stint on a station and train for every eventuality. Their schedules are much more loosely planned than those of Shuttle astronauts, who spend only a few precious days in space and must put virtually every minute to productive use. In addition, Mir cosmonauts have evenings and weekends off. (In practice, the cosmonauts often work in their free time, either because they are highly self-motivated or because experiments require it.)

Krikalev further stated that living conditions on the station depend heavily on the preferences of the resident crew. Krikalev stated that levels of cleanliness and odors varied according to the standards the resident crew was willing to accept. Similarly, the level of clutter varied considerably. Krikalev stated that, on his stays, Mir was kept relatively tidy. The crews he was part of attempted to keep unused equipment and supplies behind the wall panels, and attempted to avoid attaching netting full of equipment to the station's ceiling.⁹⁴

Mir relies much more heavily on automation than previous DOS-type stations, part of a general Soviet trend toward increasing automation in manned spacecraft. This is also evidenced by Soyuz-TM and Progress-M modifications. A French publication called it "the first computerized station in orbit." In addition to the station's control computers, each cosmonaut has a personal computer.⁹⁵ The station was launched with the Argon 16B computer. In 1990, its more capable Salyut 5B replacement, which had been delivered by Kvant 2 in 1989, was phased in.

Mir was launched with its front longitudinal port equipped with the Kurs ("course") rendezvous system used by Soyuz-TM (and now also by Progress-M). The rear port was equipped with the older Igla system so Progress freighters could continue to dock there, and also to permit docking by Igla-equipped Kvant in April 1987. The rear port of Kvant was equipped with both Igla and Kurs. The Igla system is no longer used.

Attachment of the Kvant module blocked—apparently permanently—the orbit maintenance engines on the Mir base block. All orbit maintenance maneuvers since 1987 have been conducted by docked spacecraft (Progress, Progress-M, and Soyuz-TM).

The Mir pressure hull is chemically-milled aluminum sheet averaging 2 mm thick, welded to webs 4 mm thick. The hull is 5 mm thick in the area of the multipoint docking unit, and 1.2 mm thick in the area of the small-diameter work compartment. The large-diameter compartment is covered by a 2-mm-thick radiator with a 20-mm standoff from the hull. Other portions of the hull are covered by a multilayer thermal blanket comprising on average 25 layers of aluminized Mylar and scrim. Each layer is 5 micrometers

thick. Layers of kevlar-like material cover the thermal blanket.⁹⁶

The cosmonauts have two separate cabins (pockets in the walls of the large-diameter compartment) for sleep and privacy. A sealed lavatory compartment is located in the wall aft of one of the compartments. Storage drawers take up much of the wall space in both the large- and small-diameter compartments.

Mir has many portholes, with shutters to protect them from orbital debris impacts and deposits formed through use of the attitude control engines. Each cosmonaut cabin has a small porthole, and there is a porthole in the station's "floor" for Earth observation.

The lavatory compartment has a spherical hair-washing unit with rubber gaskets through which the head and hands can be inserted.

The living area (large- and small-diameter sections) measures 7.6 m in length. The small-diameter section has dark-green floor and light-green

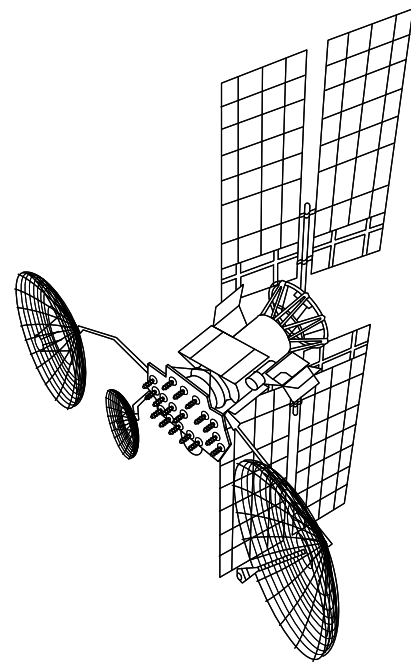

Figure 2-13. Altair/SR relay satellite.

walls; the large-diameter section has a brown floor and yellow walls. Both sections have white ceilings with fluorescent lighting.

The exercise area of Mir is also a theater with equipment for watching videocassettes and listening to music while exercising.⁹⁷ The Mir velogometer (exercise bike) can retract into the floor. There is also a treadmill/running track.

Mir's "sick bay" is a cabinet located in the frustum linking the large- and small-diameter sections of the living compartment, near the exercise area. Mir's control console faces the

forward docking unit, as on earlier DOS-type Salyuts. Two television screens permit face-to-face communications with the TsUP. Four more, arranged in pairs on either side of the hatch separating the living compartment from the multiport docking unit, permit monitoring of the modules attached to the multiport node (one screen per module).

Different fates have been proposed for Mir over the past several years. At one time, a Buran space shuttle was to have delivered a new base block in 1992. Buran would have used a manipulator arm to pluck free the add-on modules on the existing

base block and dock them to the new one. The old base block would then have been returned to Earth in Buran. According to Yuri Antoshechkin, Deputy Flight Director for Mir Systems, Mir will host its last crew in 1997, by which time its base block will have been in orbit for eleven years (more than twice as long as originally planned). It will continue flight in unmanned mode for a further year, serving as an experiment platform for a solar dynamic power system jointly developed by the U.S. and Russia. The station may then be deorbited over a preselected area of the Pacific Ocean, as was done with several of the Salyut stations.⁹⁸

2.9.3 Mir Career to Date

Changes in the configuration of the Mir station have included dockings by new modules; assembly of new components; dockings by Soyuz-T, Soyuz-TM, Progress, and Progress-M spacecraft; and Soyuz-TM transfers from port to port. The icons on the following pages depict these changes. Aligned horizontally with each icon are names (arranged to match icon positions) of spacecraft and station modules depicted and the inclusive dates of the configuration. The Mir station is left in the same orientation (forward end left) throughout this section because it did not rotate during port transfers (as did Salyut 6 and Salyut 7). In later combinations in this section, Kvant sprouts an inclined bar, which is later capped with a small rectangle. This represents the Sofora girder and subsequent addition of the VDU thruster unit atop Sofora. The text blocks cover important hardware-related events, such as anomalies and EVAs. Refer to figure 2-10 for key to icons. For more information on Soyuz-T, Progress, Soyuz-TM, and Progress-M vehicles mentioned, see section 1.12.3.4, 1.10.4.4, 1.13.3, and 1.11.3. For more information on Kvant, Kvant 2, Kristall, and the Kvant FSU, see sections 3.5, 3.6, 3.7, 3.8.1.



Mir

February 19-March 15, 1986

Mir launch. Salyut 7/Cosmos 1686 remained in orbit while Mir was launched. Because it was a ton heavier than its precursors, Mir reached an initial mean altitude of only 235 km. It was maneuvered using its main engines to a mean altitude of 330 km within a few days. Mir launch time was set by the need to match planes with the Salyut 7/Cosmos 1686 complex for the planned transfer by Soyuz-T 15 from Mir to the older station.

2.9.3.1 Mir Principal Expedition 1 (Salyut 7 Principal Expedition 6)

Leonid Kizim, Vladimir Solovyov
Crew code name—Mayak
Soyuz-T 15, March 13-July 16, 1986
73 days on Mir

Kizim and Solovyov stayed aboard Mir in two stints (52 days and 21 days) separated by a visit to Salyut 7 (51 days). Total time in space was 124 days.

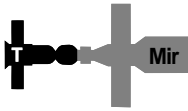

Soyuz-T 15 • Mir

March 15-21, 1986

Unusual docking procedure. The Soviets intended to dock Soyuz-T 15 with Mir's forward port, leaving the aft port free for arriving Progress spacecraft. However, Soyuz-T 15, like its Soyuz-T precursors, was equipped with the Iгла approach system, not the Kurs system used on Mir's front port. Soyuz-T 15 approached Mir from behind. At 20 km Soyuz-T 15's Iгла system acquired its counterpart on Mir's aft port. At 200 m the Iгла system was shut off, and the Mayaks manually maneuvered around the station to dock at the front port. They used the same laser range finder used by Soyuz-T 13 to dock with the uncooperative Salyut 7 station in 1985.⁹⁹



Soyuz-T 15 • Mir • Progress 25

March 21-April 20, 1986

Altair/SR tests. First tests of the Soviet data and voice relay system, the Altair/SR system, were conducted on March 29 using Mir's large aft antenna and the geosynchronous (95° E) Cosmos 1700 satellite.

Rezonans tests. The Mayaks conducted Rezonans tests of the Soyuz-T 15-Mir base block-Progress 25 complex on March 31.

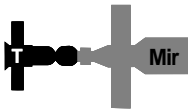

Soyuz-T 15 • Mir

April 20-26, 1986

More Rezonans tests. The Mayaks subjected the Mir base block-Soyuz-T 15 assemblage to further Rezonans tests. They also for the first time placed Mir in gravity gradient stabilization mode, with its long axis pointed toward the center of the Earth, and tested the station's atmosphere.



Soyuz-T 15 • Mir • Progress 26

April 26-May 5, 1986

Getting ready for the transfer to Salyut 7. The Mayaks loaded Soyuz-T 15 with their personal belongings, plants grown on Mir, and other items in preparation for the trip to Salyut 7, which was about 4000 km ahead of Mir in a lower orbit. On May 4 Mir was lowered by 13 km to speed the approach to Salyut 7 and conserve Soyuz-T 15's limited fuel supply for the transfer.



Mir • Progress 26

May 5-23, 1986



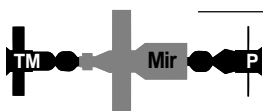

Soyuz-T 15 transfers to Salyut 7. Soyuz-T 15 separated from Mir when Salyut 7 was 2500 km away. The crossing required 29 hr.



Soyuz-TM 1 • Mir • Progress 26

May 23-29, 1986

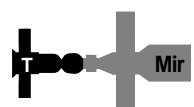

Mir's Soyuz tested. Just as Soyuz-T represented a Soyuz upgrade for Salyut 7, Soyuz-TM represented an upgrade for Mir. Soyuz-TM 1 arrived unmanned at the unoccupied station and remained for 9 days.

	Mir • Progress 26	May 29-June 22, 1986
	Mir	June 22-26, 1986
Preparations to receive Soyuz-T 15. Mir maneuvered twice June 24-25, raising its orbit slightly and moving closer to Salyut 7. On June 25 Soyuz-T 15 undocked from Salyut 7 and began the 29-hr journey back to Mir.		
	Soyuz-T 15 • Mir	June 26-July 16, 1986
The Mayaks return to Mir. Soyuz-T 15 arrived at Mir with a cargo of 350-400 kg of instruments from Salyut 7. On July 3 Kizim surpassed Valeri Ryumin's record for time spent in space. On July 6 he became the first human to spend a full year in space. The Mayaks spent their last 20 days on Mir conducting Earth observations.		
	Mir	July 16, 1986-January 18, 1987
Mir to remain unmanned until 1987. Shortly after the Mayaks returned to Earth, Soviet sources announced that Mir would not be staffed again in 1986.		
Cosmos 1700 fails. In September 1986 the Altair/SR relay satellite Cosmos 1700 ceased operating and drifted off its geosynchronous orbit position.		
	Mir • Progress 27	January 18-February 7, 1987
Computer problems on Mir. Progress 27 boosted Mir's mean altitude by 16 km to 345 km on January 26. Alexandr Laveikin, who was soon to be launched on Soyuz-TM 2 to Mir, told an interviewer during this period that only one of Mir's computers was functional. ¹⁰⁰		

2.9.3.2 Mir Principal Expedition 2 (a)

Yuri Romanenko, Alexandr Laveikin
 Crew code name—Tamyр
Soyuz-TM 2, February 5-July 30, 1987
 176 days in space

See Mir Principal Expedition 2 (b) note.

	Soyuz-TM 2 • Mir • Progress 27	February 7-23, 1987
	Soyuz-TM 2 • Mir	February 23-March 5, 1987

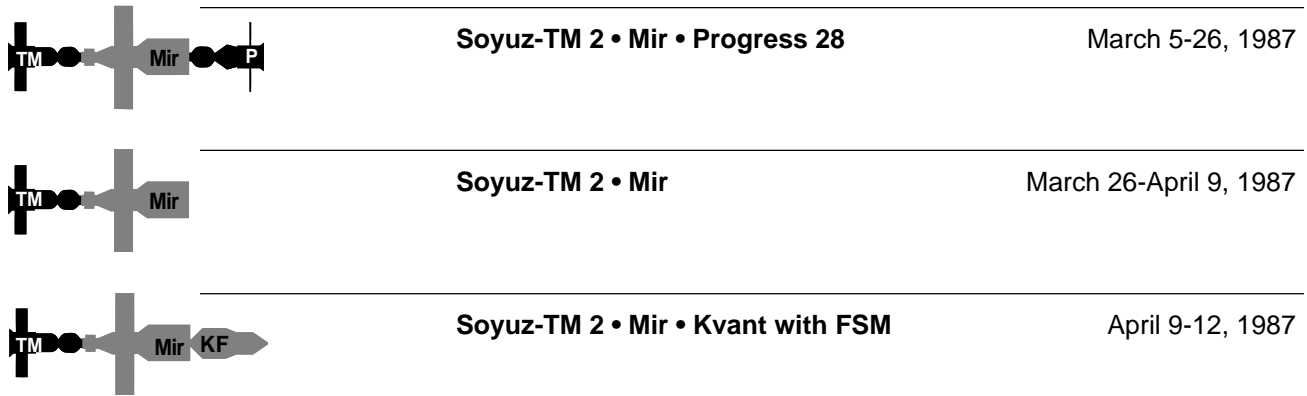

Kvant misses Mir. Kvant consisted of the space station module (11 tons) and a unique FGB-based vehicle called the Functional Service Module (FSM)(9.6 tons). The FSM carried out major maneuvers on April 2 and April 5. On April 5 its Igla approach system began homing on Mir’s aft port. The Tamyr’s retreated to Soyuz-TM 2 so that they could escape in the event the module got out of control. About 200 m out, the Igla system lost its lock on Mir’s aft port Igla antenna. The cosmonauts watched from within Soyuz-TM 2 as the Kvant/FSM combination passed within 10 m of the station.

Kvant achieves soft dock. Kvant and its FSM drifted 400 km from Mir before being guided back for a second docking attempt. Soft-dock occurred early on April 9. Kvant’s probe unit would not retract fully, preventing hard docking between Mir and Kvant. The Soviets left Kvant soft-docked while they considered a solution. Maneuvers were impossible during this period, because the probe of the Kvant/FSM combination would wobble loosely in Mir’s aft port drogue unit, banging the docking collars together.¹⁰¹

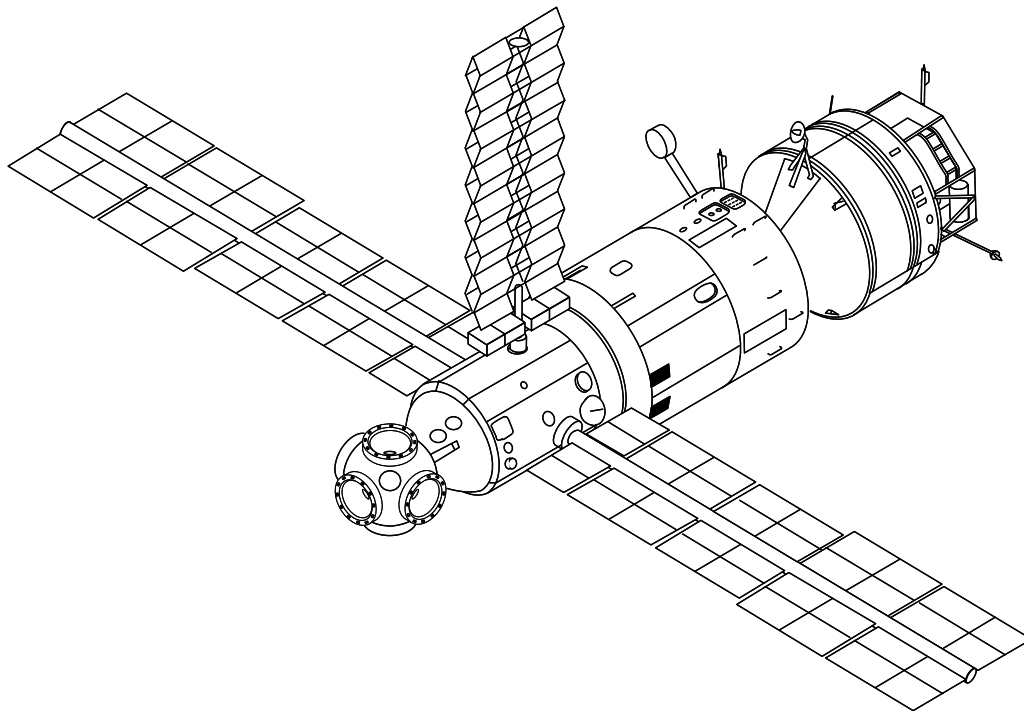

Figure 2-14. Mir base block (left) and Kvant (right) (1987). Note third solar array added to the top of the Mir base block. It was delivered inside Kvant. Soyuz-TM and Progress vehicles omitted for clarity.

Emergency EVA and hard dock. On April 11 Romanenko and Laveikin exited Mir to examine and, if possible, repair the problem with Kvant. They discovered a foreign object lodged in the docking unit, probably a trash bag they had left between Progress 28 and Mir's drogue. On command from the TsUP, Kvant extended its probe unit, permitting the cosmonauts to pull the object free and discard it into space. Kvant then successfully completed docking at a command from the ground. The EVA lasted 3 hr, 40 min. The Kvant FSM undocked from Kvant on April 12, freeing the module's aft port to fill in for the Mir aft port (figure 2-14).¹⁰²



Soyuz-TM 2 • Mir • Kvant

April 12-23, 1987

Unloading Kvant. The Tamyr entered Kvant on April 13 and began unloading equipment into the base block. Kvant added 40 m³ of pressurized volume to Mir, bringing the total to about 130 m³. On April 16 the pointing motors on Mir's two solar arrays were linked to sensors on Kvant. Kvant carried stowed solar arrays intended to be attached to a fixture on top of the small-diameter section of the base block.

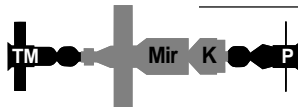

Soyuz-TM 2 • Mir • Kvant • Progress 29

April 23-May 11, 1987

Testing Kvant. Beginning April 30, the Tamyr tested orienting the Mir complex using Kvant's gyrodynes. In part this was in preparation for pointing the new module's roughly 1000 kg of astrophysical instruments.

Progress 29's short stay. During this period, propellant was pumped through Kvant to Mir's ODU for the first time. The Elektron system aboard Kvant, which produced oxygen by electrolysis of water, was readied on May 8.



Soyuz-TM 2 • Mir • Kvant

May 11-21, 1987

Mir power shortage. The Soviets acknowledged that Mir was short on electricity. The situation became particularly difficult when melts lasting days were conducted using Korund 1-M. The Tamyr spent most of May conducting medical experiments and Earth resources photography, activities which required little electricity.¹⁰³



Soyuz-TM 2 • Mir • Kvant • Progress 30

May 21-July 19, 1987

First and second EVAs—solar array installation. On June 12 the Tamyr exited Mir's multiport node for the first of two EVAs to install the solar array delivered by Kvant. There was insufficient room available in the multiport node for two spacesuited cosmonauts plus the main boom and first two sections of the new array, so Laveikin and Romanenko sealed the hatch between the Soyuz-TM 2 docking module and orbital module and left the hatch between the orbital module and the multiport node open, creating an extended airlock. One cosmonaut worked outside while the other handed out needed parts. The main boom of the array was an extendible girder like the one assembled outside Salyut 7 by the Mir Principal Expedition 1/Salyut 7 Principal Expedition 6 crew (Kizim and Solovyov, 1986). The first EVA lasted less than 2 hr. The second EVA, on June 16, installed the remainder of the

solar array, attached its electrical connections to the Mir power system, and extended it to its full 10.6-m length. The new, 22-24 m³ array brought Mir's total capacity to 11.4 kW. The EVA lasted 3 hr, 15 min.

Kvant begins its astronomical work with a bang. The Roentgen Observatory on Kvant was uniquely placed to study Supernova 1987a in the Large Magellanic Cloud. The cosmonauts examined the exploding star during 115 sessions between June and September.



Soyuz-TM 2 • Mir • Kvant

July 19-24, 1987

2.9.3.3 Mir Principal Expedition 2 (b)

Yuri Romanenko, Alexandr Alexandrov
 Crew code name–Tamyр
Soyuz-TM 3, July 22-December 29, 1987
 160 days in space

Romanenko remained on Mir after Laveikin's departure in Soyuz-TM 2. Laveikin replaced by Alexandrov from Soyuz-TM 3. Romanenko's total stay time on long-duration expeditions Mir-2 (a) and Mir-2 (b) was 336 days.



Soyuz-TM 2 • Mir • Kvant • Soyuz-TM 3

July 24-29, 1987

Soyuz-TM 3. Syrian guest cosmonaut Mohammed Faris and Soviet cosmonaut Alexandr Viktorenko returned to Earth in Soyuz-TM 2 with Alexandr Laveikin, who was diagnosed by ground-based doctors as having minor heart problems. He was replaced by Alexandr Alexandrov. The Visiting Expedition observed Syria and conducted materials processing experiments.¹⁰⁴

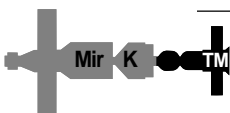

Mir • Kvant • Soyuz-TM 3

July 29-30, 1987



Soyuz-TM 3 • Mir • Kvant

July 30-August 5, 1987



Soyuz-TM 3 • Mir • Kvant • Progress 31

August 5-September 21, 1987

X-rays from Supernova 1987a. On August 10 the astrophysical instruments on Kvant became the first to detect X-rays from Supernova 1987a. On August 31 the cosmonauts conducted a preplanned emergency evacuation drill, retreating to Soyuz-TM 3.



Soyuz-TM 3 • Mir • Kvant

September 21-26, 1987

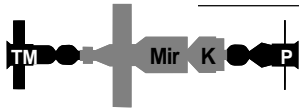

Soyuz-TM 3 • Mir • Kvant • Progress 32

September 26–November 17, 1988

Progress 32 docking test. At 0409 UT on November 6, Progress 32 backed away from Mir to 2.5 km. It redocked at 0547 UT, in a test designed to study ways of reducing the amount of fuel used during approach and docking operations.¹⁰⁵

Soyuz-TM 3 • Mir • Kvant

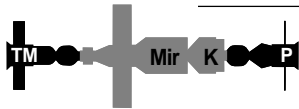
November 17–23, 1987

Soyuz-TM 3 • Mir • Kvant • Progress 33

November 23–December 19, 1987

Kvant problems. By late in the year, investigators in Britain and Holland noted sporadic problems with their TTM wide-angle X-ray camera and with ESA's Sirene 2 gas-scintillation proportional counter. They queried the TsUP in Moscow as to whether crew activity could be causing interference with the instruments.¹⁰⁶

Cosmos 1897. This was a communications relay satellite of the Altair/SR series, designed to increase the amount of time Mir could be in touch with the TsUP on each orbit. It was launched on November 26 and stationed in geosynchronous orbit at 95° E. At the same time, fatigue reduced the cosmonauts' workday to 4.5 hr.^{107, 108}

Soyuz-TM 3 • Mir • Kvant

December 19–23, 1987

2.9.3.4 Mir Principal Expedition 3

Vladimir Titov, Musa Manarov

Crew code name—Okean

Launched in **Soyuz-TM 4**, December 21, 1987Landed in **Soyuz-TM 6**, December 21, 1988

365 days in space

Valeri Polyakov joined Titov and Manarov on Mir August 31, 1988, arriving on Soyuz-TM 6. See Mir Principal Expedition 4 note.

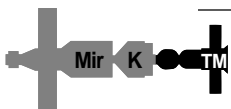
Soyuz-TM 3 • Mir • Kvant • Soyuz-TM 4

December 23–29, 1987

Handover. Before departing Mir, Romanenko and Alexandrov demonstrated use of EVA equipment to the Okeans. The Okeans delivered biological experiments, including the Aynur biological crystal growth apparatus, which they installed in Kvant. The combined crews conducted an evacuation drill, with the Mir computer simulating an emergency.

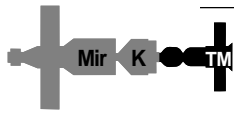

Mir • Kvant • Soyuz-TM 4

December 29-30, 1987

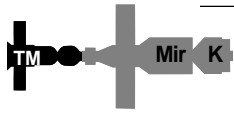

Soyuz-TM 4 • Mir • Kvant

December 30, 1987-January 23, 1988

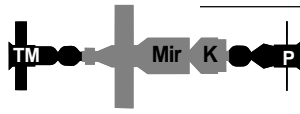

Soyuz-TM 4 • Mir • Kvant • Progress 34

January 23-March 4, 1988

Glazar operations. Titov and Manarov conducted part of an ongoing survey of galaxies and star groups in the ultraviolet part of the spectrum using the Glazar telescope on Kvant. The survey required photography with exposure times up to 8 min. Even small cosmonaut movements could shake the complex. This produced blurring of astronomical images, so all cosmonaut movements had to be stopped during the exposures.

First EVA—solar array work. On February 12 the cosmonauts began preparations for an EVA to replace and augment Mir’s solar arrays. They tested their EVA suits February 23-25, and on February 26 they exited the station. The Okeans removed one portion of the array Romanenko and Laveikin had assembled in June 1987. They replaced it with an eight-part array set which increased electricity output by 20% and also tested new solar cell materials and allowed telemetric monitoring of output. They also found time to wipe several of Mir’s portholes, which had accumulated a dusty coating, and extensively photographed Mir’s exterior. The EVA lasted 4 hr, 25 min.



Soyuz-TM 4 • Mir • Kvant

March 4-25, 1988

Sounds and smells. On March 17 the cosmonauts studied the effects of noise produced by fans and other equipment on their living quarters as part of the Akustika experiment. During the same period, a Soviet spokesman stated that dust and odors on Mir bothered the cosmonauts.¹⁰⁹

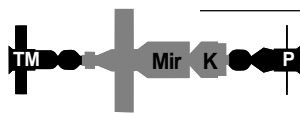

Soyuz-TM 4 • Mir • Kvant • Progress 35

March 25-May 5, 1988

Communications system upgrades. In late March and early April, Titov and Manarov installed and tested a new telefax system and unspecified equipment to improve communications between Mir and Earth.



Soyuz-TM 4 • Mir • Kvant

May 5-15, 1988

Orbital debris impact. During May a particle the Soviets identified as a piece of space debris blasted a crater in a two-pane Mir viewport. The damaged area was 6-8 mm across.¹¹⁰



Soyuz-TM 4 • Mir • Kvant • Progress 36

May 15-June 5, 1988



Soyuz-TM 4 • Mir • Kvant

June 5-9, 1988



Soyuz-TM 4 • Mir • Kvant • Soyuz-TM 5

June 9-17, 1988

Bulgarian in space. Before this flight, Bulgaria was the only eastern European Soviet ally not to have had a citizen visit a Soviet space station. This was because of the Soyuz 33 failure in 1979. Bulgarian cosmonaut-researcher Alexandr Alexandrov, not to be confused with the Soviet cosmonaut of the same name, used nearly 2,000 kg of equipment delivered by Progress freighters to conduct 46 experiments in the Shipka program during his stay on Mir.

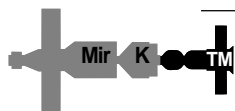

Mir • Kvant • Soyuz-TM 5

June 17-18, 1988

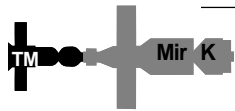

Soyuz-TM 5 • Mir • Kvant

June 18-July 20, 1988

Second EVA—X-ray telescope repair fails. On June 30 the Okeans left Mir via one of the lateral ports for an unrehearsed EVA to replace Kvant's TTM shadow mask X-ray telescope. They had trained for the EVA by videotape sent up by the Progress 38 supply ship along with needed tools. They also spoke with cosmonauts who had rehearsed the repair in the hydrobasin in Zvezdny Gorodok ("Star City"). In addition to their suits, the Okeans carried 40 kg of tools and equipment between them. Upon reaching the work site, they cut through 20 layers of thermal blanket to reach the Roentgen suite of instruments. The EVA ended unsuccessfully when a wrench needed to remove a clamp snapped. The EVA duration was 5 hr, 10 min.



Soyuz-TM 5 • Mir • Kvant • Progress 37

July 20-August 12, 1988

Cosmos 1897 moves east. In late July the Altair/SR relay satellite Cosmos 1897 was moved from its station at 95° E to 12° E to support the Buran shuttle test flight of November 14, 1988.

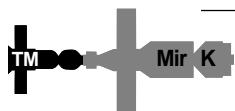

Soyuz-TM 5 • Mir • Kvant

August 12-31, 1988



Soyuz-TM 5 • Mir • Kvant • Soyuz-TM 6

August 31-September 5, 1988

Soyuz-TM 6 arrives. Its crew had a unique makeup, with a commander (Vladimir Lyakhov) who had been trained to fly a Soyuz-TM solo in the event a rescue ship needed to be sent to recover two cosmonauts from Mir, no flight engineer, and two inexperienced cosmonaut-researchers. One was Dr. Valeri Polyakov, who would remain aboard Mir with Titov and Manarov to monitor their health during the final months of their planned year-long stay. The other

was Intercosmos cosmonaut Abdul Ahad Mohmand, from Afghanistan. Mohmand's experiment program was dominated by a series of observations of Afghanistan, called Shamshad. During return to Earth, Soyuz-TM 5 suffered a combined computer software and sensor problem, which delayed its reentry by 24 hr.

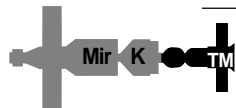

Mir • Kvant • Soyuz-TM 6

September 5-8, 1988



Soyuz-TM 6 • Mir • Kvant

September 8-12, 1988



Soyuz-TM 6 • Mir • Kvant • Progress 38

September 12-November 23, 1988

Third EVA—X-ray telescope repair succeeds. On October 20 Titov and Manarov stepped outside Mir, leaving Polyakov in the Soyuz-TM 6 descent module. The spacewalkers wore improved spacesuits which did not need an umbilical connection to the station. Using tools delivered by Progress 38, Titov and Manarov removed the old TTM shadow mask X-ray unit and successfully replaced it. They then installed equipment in anticipation of the upcoming Franco-Soviet EVA. The EVA lasted 4 hr, 12 min.



Soyuz-TM 6 • Mir • Kvant

November 23-28, 1988

2.9.3.5 Mir Principal Expedition 4

Alexandr Volkov, Sergei Krikalev, Valeri Polyakov

Crew code name—Donbass

Soyuz-TM 7, November 26, 1988-April 27, 1989

151 days in space

Polyakov remained on Mir with Volkov and Krikalev when Titov and Manarov returned to Earth in Soyuz-TM 6. Polyakov's total stay time (part of Principal Expedition 3 and all of Principal Expedition 4) was 242 days. See Mir Principal Expedition 3 note.



Soyuz-TM 6 • Mir • Kvant • Soyuz-TM 7

November 28-December 21 1988

Long French visit to Mir— the Franco-Soviet Aragatz mission begins. The arrival of Soyuz-TM 6 with French cosmonaut Jean-Loup Chretien (on his second mission to a Soviet space station) and Soviet cosmonauts Alexander Volkov and Sergei Krikalev increased Mir's population to six. According to Krikalev, this was the "worst-case scenario" as far as crowding on the station was concerned. Not only were there more cosmonauts than usual aboard Mir; the station was also full of equipment and life support supplies delivered by

Progress freighters for the joint Franco-Soviet mission. The crowding was exacerbated because there was no docking port free for a Progress freighter. Therefore, the crew could not use a Progress as a “pantry” or “storage room” for the station. The large joint experiment manifest—mostly medical and technology experiments chosen to support the French-led European Space Agency Hermes shuttle project—strained Mir’s electricity supply. The total mass of the experiments was 580 kg.^{111, 112, 113}

French EVA. Preparations for the first EVA involving a non-Soviet/non-U.S. space traveler forced the cosmonauts to cut short a TV meeting with diplomats from 47 countries on December 8. On December 9 Chretien and Volkov depressurized the multiport docking adapter and clambered outside Mir. Chretien was first out. He installed handrails, then attached the 15.5 kg Enchantillons experiment rack to the handrails by springs and hooks. He also attached electrical wires leading from the rack to Mir’s power supply. Enchantillons carried five technological experiments with applications to the Hermes shuttle program. Volkov and Chretien then assembled the 240-kg ERA experiment. They attached a mount to handrails on the frustum linking the multiport docking unit to the small-diameter portion of the work compartment. After resolving problems with cables linking ERA to a control panel inside Mir, they attached the folded ERA structure to a support arm on the platform. The structure was designed to unfold to form a flat six-sided structure 1 m deep by 3.8 m across. From inside Mir, Krikalev commanded the structure to unfold, but to no avail. Volkov then kicked ERA, causing it to unfold properly. According to Krikalev, taking the ERA outside helped relieve the crowding problems. The EVA lasted 5 hr and 57 min.^{114, 115}

The Aragatz mission ends. After the EVA, Titov and Manarov showed Krikalev and Volkov the peculiarities of living and working on Mir. On December 15, their 359th day in space, Titov and Manarov officially beat Romanenko’s 326-day single-flight endurance record by the required 10%. On December 19, Soyuz–TM 6 was powered up for descent. The spacecraft undocked on December 21. Titov, Manarov, and Chretien landed under low clouds, in sub-freezing temperatures, near Dzhezhkazgan in Kazakhstan.¹¹⁶



Progress 39 boosts orbit. Orbit boost was necessary because of greater than normal atmospheric drag. This in turn was caused by atmospheric expansion produced by atmospheric heating, the result of solar activity during the solar maximum period. According to Krikalev, it was not possible to visually detect any difference in the station’s altitude after the reboost was completed. Krikalev, Volkov, and Polyakov then cleaned Mir and loaded Progress 39’s orbital module with waste and excess equipment used on the joint Franco-Soviet Aragatz mission.¹¹⁷

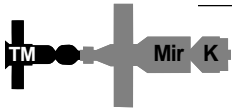

Soyuz-TM 7 • Mir • Kvant

February 7-12, 1989

Cosmos 1897 moves west. During February the Altair/SR satellite was moved from 12° E to its original position at 95° E.

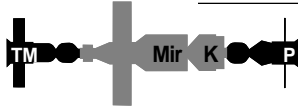

Soyuz-TM 7 • Mir • Kvant • Progress 40 February 12-March 3, 1989

D-module (Kvant 2) delayed. In mid-February the Soviets announced that launch of the D-module (also called the augmentation module, or Kvant 2) was the victim of delays in the production of the module to be added after it, the T-module (technology module, or Kristall). The D-module had been at Baikonur, awaiting launch, since July 1988, but the T-module would not be ready until December 1989, and the Soviets did not wish to let 3 months go by with Mir in an asymmetrical configuration (that is, with only one lateral port filled). Rather than handing over to another Principal Expedition crew, the Donbass cosmonauts would mothball Mir and return to Earth at the end of their stint.¹¹⁸

EVAs cancelled. Krikalev and Volkov had been trained to perform a total of six EVAs during Mir Principal Expedition 4. Krikalev was to have been the first cosmonaut to fly the Soviet equivalent of the NASA manned maneuvering unit (MMU), the YMK. But delay of Kvant 2, which carried the YMK, pushed back the EVAs to the next Principal Expedition, the crew for which would consist of Krikalev and Volkov's backups.

Diagramma. The cosmonauts extended a 10-m pole from the Mir base block's small airlock. It carried sensors used as part of the Diagramma program to characterize the environment around Mir.

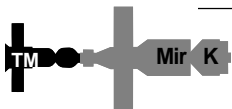

Soyuz-TM 7 • Mir • Kvant

March 3-18, 1989

Antenna experiment. When Progress 40 backed away from Mir, it deployed an antenna consisting of two loops of wire, each 20 m across, from a pair of containers on either side of the Progress cargo module. The cosmonauts observed the deployment. During the 2 days before its destructive reentry, Progress 40 continued in free flight while characteristics of the antenna were assessed by the TsUP.



Soyuz-TM 7 • Mir • Kvant • Progress 41

March 18-April 21, 1989

Mir mothballed. On April 10 Soviet reports had the cosmonauts beginning the process of preparing Mir for unmanned operation. Also during this period the cosmonauts replaced power supply units which were nearing the end of their design lives. Heightened solar activity led to some concern over the cosmonauts' safety, but Soviet sources stated that radiation levels were not hazardous.

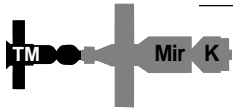
**Soyuz-TM 7 • Mir • Kvant**

April 21-26, 1989

Soyuz-TM 7 leaves Mir unstaffed. The engine on Soyuz-TM 7 was used to boost the Mir complex to a new record mean altitude of 410 km in mid-April. Volkov, Krikalev, and Polyakov then loaded Soyuz-TM 7 with experiment results and film and returned to Earth. The landing was unusually rough because of high winds in the recovery zone. Krikalev sustained a minor knee injury, though he downplayed its importance.¹¹⁹

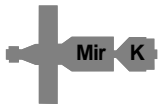
**Mir • Kvant**

April 26-August 25, 1989

Astronomical observations. Throughout the time it was unstaffed, astronomers on Earth used Mir's Kvant astrophysical instruments to study Supernova 1987a and conduct more than 70 other observations.

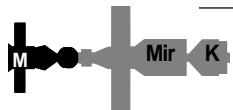
**Progress-M 1 • Mir • Kvant**

August 25-September 6, 1989

Progress-M 1 arrives. This was the first flight of a modified Progress freighter. It became the first of its class to dock with the front port of a space station. While there, it topped off the station's attitude control propellant tanks.

2.9.3.6 Mir Principal Expedition 5

Alexandr Viktorenko, Alexandr Serebrov

Crew code name—Vityaz

Soyuz-TM 8, September 5, 1989-February 19, 1990

168 days in space.

**Progress-M 1 • Mir • Kvant • Soyuz-TM 8**

September 6-December 1, 1989

Docking system work. On September 29 the cosmonauts installed equipment in the docking system in preparation for the arrival of Kvant 2, the first of Mir's 20-ton add-on modules.

Solar storm warnings. On September 30 a powerful flare burst out on the Sun. Initial predictions indicated that the cosmonauts could receive many times the maximum permissible level of radiation. In the event, the cosmonauts received only about as much radiation as they would normally receive in 2 weeks of flight.

Kvant 2 delayed. It was announced on October 10 that problems with a batch of computer chips pushed back the launch of Mir's second add-on module by at least 40 days from the planned October 16 launch date. The major focus of Viktorenko and Serebrov's mission was to receive, check out, and activate the module, so their schedule underwent heavy revision.



Mir • Kvant • Soyuz-TM 8

December 1-6, 1989

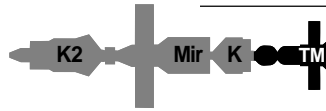

Kvant 2 • Mir • Kvant • Soyuz-TM 8

December 6-8, 1989

Kvant 2 joins Mir. Kvant 2 was launched on November 26. Soon after launch the TsUP discovered that the right solar array had not deployed properly, allowing it to flop freely. By rolling Kvant 2 and rotating the array simultaneously, the TsUP was able to fully extend and lock the array. On December 2 Kvant 2 closed to within 20 m of the Mir front port before its Kurs control system terminated the approach. It had sensed that the module was moving too fast. Problems also developed on Mir: the Argon 16B control computer shut down the attitude control gyrodynes in Kvant after detecting an error. Viktorenko and Serebrov assumed manual control of Mir for the second attempt, which was successful. The Lyappa manipulator arm on Kvant 2 then inserted itself into a fixture on the multiport docking node and pivoted the module into place at the top lateral port. The transfer required about 1 hr (figure 2-15).

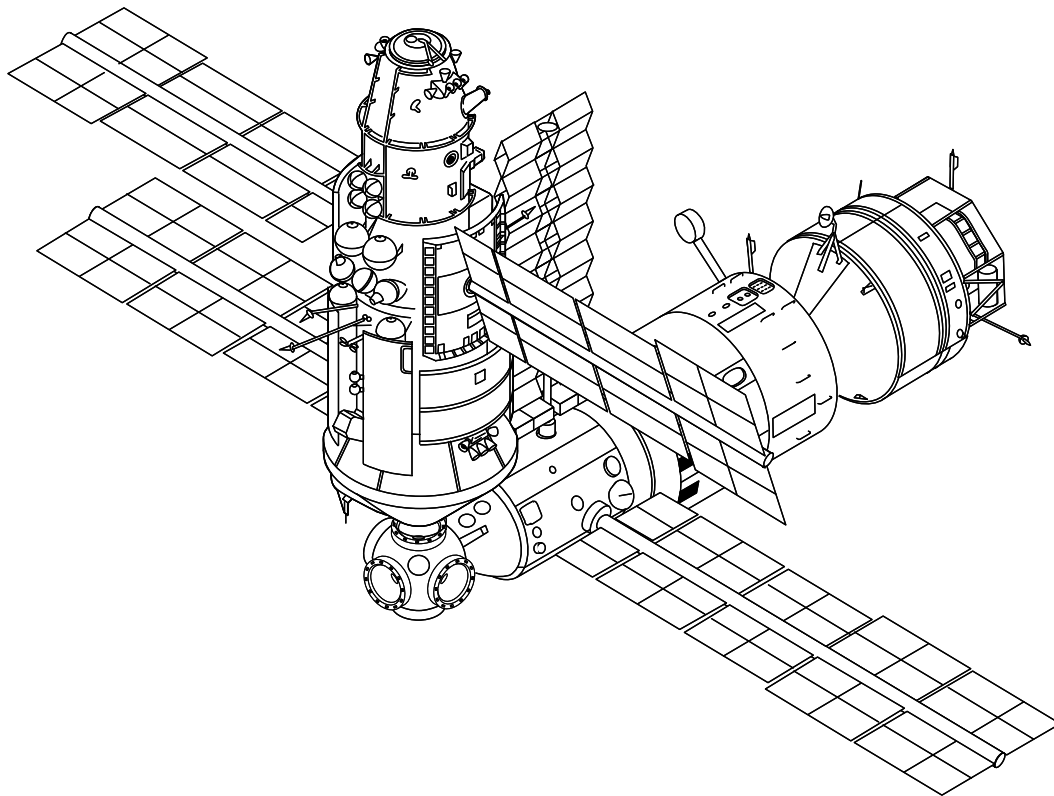
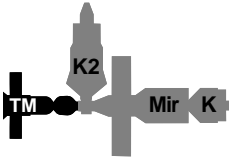

Figure 2-15. Mir base block (left), Kvant, and Kvant 2 (top) (1989). Soyuz-TM and Progress vehicles are omitted for clarity.



Kvant 2
Mir • Kvant • Soyuz-TM 8

December 8-12, 1989



Kvant 2
Soyuz-TM 8 • Mir • Kvant

December 12-22, 1989

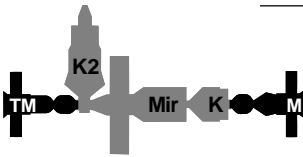

Kvant 2
Soyuz-TM 8 • Mir • Kvant • Progress-M 2

December 22, 1989-February 9, 1990

First EVA—star sensor installations. The new guidance control computer for Mir, the Salyut 5B system delivered by Kvant 2, needed star sensors more capable than those in place on Kvant. On January 8, in the first of the EVAs postponed from Principal Expedition 4, Viktorenko and Serebrov opened one of the three free docking node hatches, transferred the twin 80-kg sensor packages outside, and installed them on Kvant. Start of the 2-hr, 56-min EVA was delayed 1 hour by a depressurization problem in Soyuz-TM 8—when the cosmonauts lowered pressure in the docking node, an improperly set valve released air from the spacecraft as well.

Second EVA—many tasks. On January 11 the cosmonauts became the last to use a docking node hatch for an EVA. They removed for return to Earth the Enchantillons space exposure experiment rack set up by Chretien during his December 1988 EVA, removed and discarded the ERA platform installed by Chretien and Volkov, and made modifications to the docking node in preparation for the arrival of the next large module, Kristall.

Cosmos 2054. The third Altair/SR geosynchronous satellite took up position at 344° E in mid-January. It was launched on December 27, 1989. Combined with Cosmos 1897, it permitted Mir to maintain contact with the TsUP in Moscow about 70% of the time.

Third EVA—testing new EVA systems. On January 26 Viktorenko and Serebrov donned new Orlan-DMA spacesuits. These were improved versions of the Orlan suits they had worn on their first two EVAs. They then entered and depressurized the special EVA airlock compartment at the outboard end of Kvant 2. The EVA airlock hatch is wider than the docking hatches (1 m vs 0.8 m) to permit passage of the YMK, the Soviet MMU equivalent, which is stored in Kvant 2. The central instrument-science compartment of Kvant 2 can also be sealed and depressurized, expanding the size of the airlock and providing a backup. The cosmonauts attached a mooring post to the outside of the airlock compartment and removed a Kurs antenna so it could not interfere with future EVAs. EVA duration was 3 hr, 2 min.

Fourth EVA—YMK tests. The Soviet “flying armchair” maneuvering unit weighed 218 kg. Serebrov donned the unit on February 1 and moved up to 33 m from the station. In case the YMK malfunctioned, during the test he was bound by a tether attached to a winch on the mooring post installed on the previous EVA. The EVA lasted 4 hr, 59 min.

Fifth EVA—More YMK tests. On February 5 Viktorenko flew the YMK to a distance of 45 m. He carried the Spin-6000 device, which measured radiation from Mir induced by cosmic ray bombardment. EVA duration was 3 hr, 45 min.

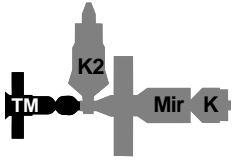

Kvant 2
Soyuz-TM 8 • Mir • Kvant

February 9-13, 1990

2.9.3.7 Mir Principal Expedition 6

Anatoli Solovyov, Alexandr Balandin

Crew code name—Rodnik

Soyuz-TM 9, February 11-August 9, 1990

179 days in space

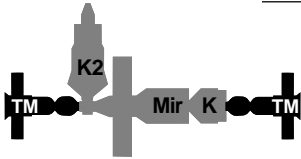

Kvant 2
Soyuz-TM 8 • Mir • Kvant • Soyuz-TM 9

February 13-19, 1990

Soyuz-TM 9 arrives in tatters. Soon after they arrived in orbit, Balandin and Solovyov noted that three of eight thermal insulation blankets on their spacecraft's descent module had come loose at their lower (heat shield) ends and were waving about as the spacecraft maneuvered in space. It was thought they could block optical navigation sensors, and that the damaged insulation might cause the spacecraft to overheat or cool down so much that condensation would form on its optical equipment. The possibility existed that an electrical short might occur if condensation developed on equipment. Docking with Mir occurred as normal. The cosmonauts and TsUP worked out procedures by which the TsUP monitored Soyuz-TM 9's temperature and maneuvered Mir to move it in and out of sunlight as needed to maintain proper temperature. In the meantime, cosmonauts worked in the hydrolab training facility in Zvezdny Gorodok, outside Moscow, to develop EVA repair procedures. Consideration was also given to sending a rescue Soyuz-TM carrying a single cosmonaut to pick up the cosmonauts and return them to Earth.¹²⁰

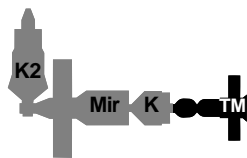

Kvant 2
Mir • Kvant • Soyuz-TM 9

February 19-21, 1990

Viktorenko and Serebrov give a press conference on Earth. Mir's previous occupants, the Vityazis, claimed that profits generated by the production of 297 g of gallium arsenide semiconductors had allowed their mission to pay for itself. The gallium arsenide had returned to Earth with them in the Soyuz-TM 8 descent module. They also complained that on Mir there were no fixtures for holding them at their work stations.¹²¹

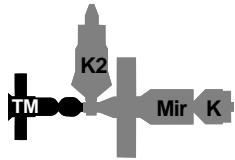

Kvant 2
Soyuz-TM 9 • Mir • Kvant

February 21-March 3, 1990

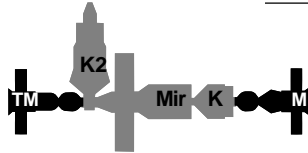

Kvant 2
Soyuz-TM 9 • Mir • Kvant • Progress-M 3

March 3-April 27, 1990

Maintenance. Progress-M 3 delivered replacement parts for Mir, including new storage batteries, electrical system components, and computer parts. The cosmonauts began installing these by March 7. Most of March was taken up with work on the computer system.

Kristall delayed. When Soyuz-TM 9 was launched, the Soviets stated that Kristall would launch on March 30 and dock April 7. On April 20 the Soviets announced that the Kristall module would not be launched until June 1. The cause of the delay was continued work to turn over control of the Mir complex to the new Salyut 5B computer. Difficulty had also been experienced in integrating Kvant 2's gyrodynes into the Mir attitude control system.¹²²

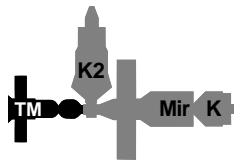

Kvant 2
Soyuz-TM 9 • Mir • Kvant • Progress-M 2

April 27-May 7, 1990

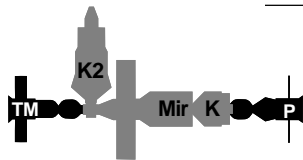

Kvant 2
Soyuz-TM 9 • Mir • Kvant • Progress 42

May 7-27, 1990

Last Progress. Progress 42 was the last of the highly successful series of Progress vehicles. It marked the 43rd Progress docking (counting Cosmos 1669), all of which were successful. The Progress freighters delivered 99 tons of material to Salyut 6, Salyut 7, and Mir. Use of Progress 42 forced a delay in the integration of the Salyut 5B control computer delivered with Kvant 2, as Progress 42 could interface only with the old Argon 16B system.

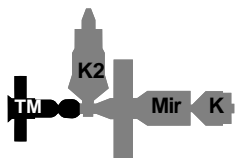

Kvant 2
Soyuz-TM 9 • Mir • Kvant

May 27-28, 1990

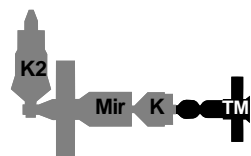

Kvant 2
Mir • Kvant • Soyuz-TM 9

May 28-June 10, 1990

June 10-11, 1990

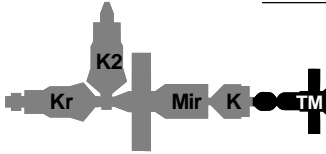

Kvant 2
Kristall • Mir • Kvant • Soyuz-TM 9

Kristall arrives. The long-awaited, much-delayed Kristall module arrived at Mir's front port on June 10, and was relocated to the lateral port opposite Kvant 2 on June 11 (figure 2-16). This restored the equilibrium of the complex, which had been asymmetrical since Kvant 2 was placed at a lateral port in December 1989. The module was launched May 31. It had aborted its first

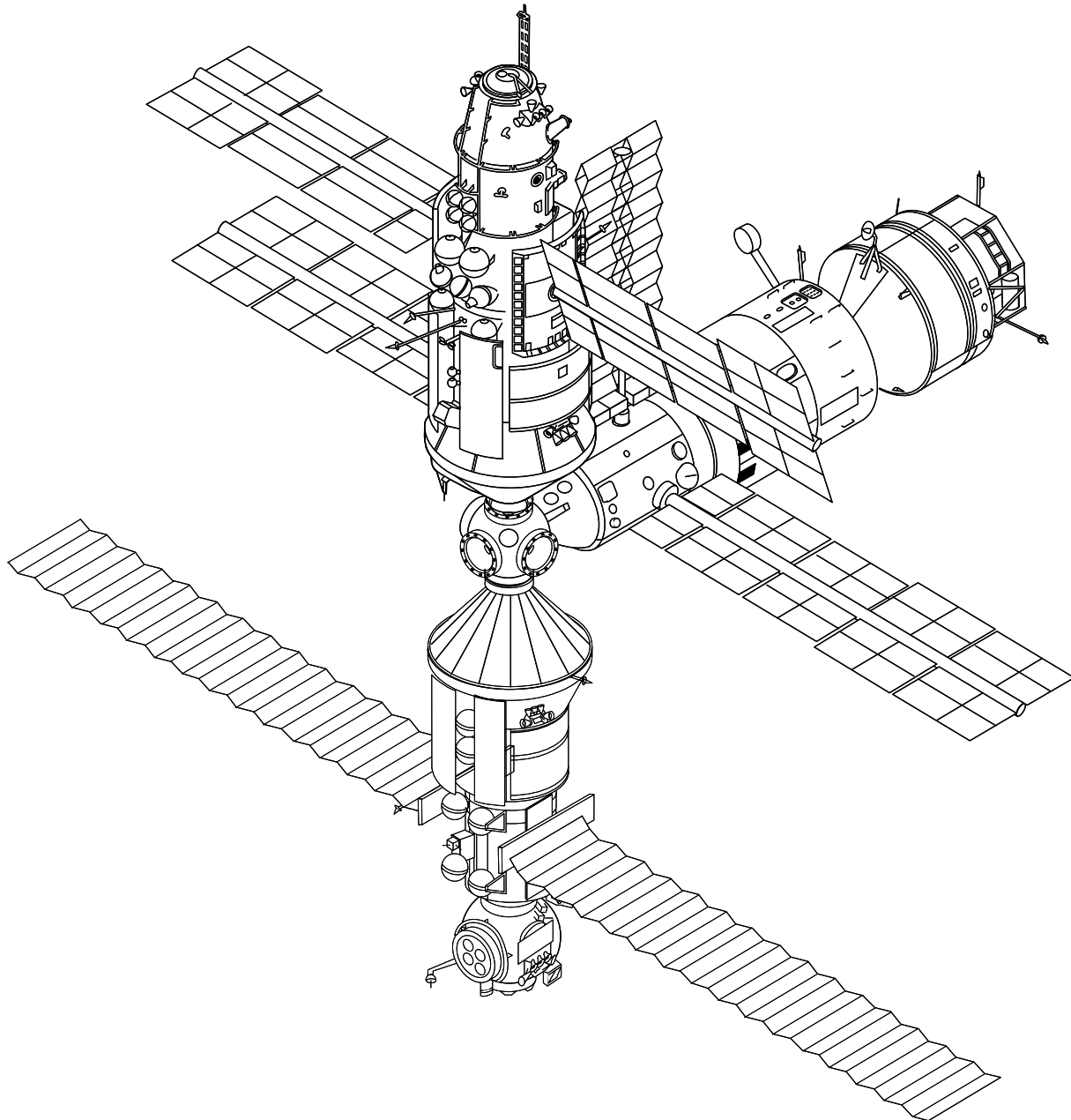
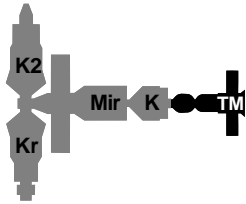

Figure 2-16. Mir base block (center), Kvant (right), Kvant 2 (top), and Kristall (bottom) (1990). Note the EVA mooring post for YMK tests near Kvant 2's EVA airlock hatch. It was added during a January 26, 1990 EVA. Soyuz-TM and Progress vehicles are omitted for clarity.

docking attempt on June 6 due to an attitude control thruster failure. Delays in launch and docking affected Balandin and Solovyov, who were scheduled to return to Earth at the end of July. Their mission was extended 10 days to permit them to activate Kristall's systems, and to accommodate the EVA to repair the loose thermal blankets on Soyuz-TM 9.



Kvant 2
Mir • Kvant • Soyuz-TM 9
Kristall

June 11-July 3, 1990

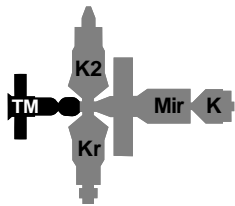

Kvant 2
Soyuz-TM 9 • Mir • Kvant
Kristall

July 3-August 3, 1990

First EVA—Kvant 2 hatch damaged. Solovyov and Balandin had not previously been trained to perform an EVA. They trained by videotape sent up from the ground on a Progress spacecraft, and also by observing practice sessions televised from the hydrobasin. Special EVA tools were manufactured and sent to the cosmonauts. On July 3 they moved Soyuz-TM 9 to the Mir front port so it could be more easily reached for repairs. On July 17 they opened the Kvant 2 EVA hatch before the airlock was completely evacuated of air. The hatch slammed back on its hinges. They used a pair of clamps, which they attached to handholds, to move down Kvant 2. They also secured themselves with long and short ropes. After 1.5 hr they reached the multiport docking node. They attached to Kvant 2 ladders for reaching the damage site on their Soyuz-TM. The cosmonauts determined that the Soyuz-TM 9 descent module remained in excellent condition. However, the thermal blankets had shrunk, making them impossible to reattach. They fell back on a contingency plan by folding two of the three blankets in half. They were well behind schedule by this point. They left their tools and ladders at the repair site and hurried to return to Mir, as the rated endurance of their suits (6.5 hr) had been exceeded. This meant crawling over Kvant 2's hull in the dark. They found that the Kvant 2 hatch would not close. To permit them to reenter the pressurized portion of Mir, the central compartment of Kvant 2 was called into play as an emergency airlock, as it had been designed to do. The EVA lasted 7 hr, 16 min.¹²³

Second EVA—sizing up the damage. Solovyov and Balandin depressurized the Kvant 2 central compartment on July 25. After several attempts to close the outside hatch from inside, they televised images of the damaged hinge to the TsUP, then returned to the multiport node to secure their ladders. Finally, they removed a portion of the hinge cover, which had broken and become lodged between the hatch and its frame. They found the hatch much easier to close and seal after this. They repressurized the EVA airlock. The EVA lasted 3 hr, 31 min.¹²⁴

2.9.3.8 Mir Principal Expedition 7

Gennadi Manakov, Gennadi Strekalov
Crew code name—Vulkan
Soyuz-TM 10, August 1-December 10, 1990
131 days in space

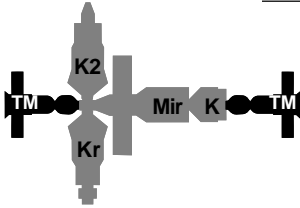

Kvant 2
Soyuz-TM 9 • Mir • Kvant • Soyuz-TM 10
Kristall

August 3-9, 1990

Soyuz-TM 10 arrives, Soyuz-TM 9 departs. The Vulkans arrived at Mir's aft port with four passengers—quail for cages in Kvant 2. A quail laid an egg en route to the station. It was returned to Earth, along with 130 kg of experiment results and industrial products, in Soyuz-TM 9. The spacecraft landed without incident.

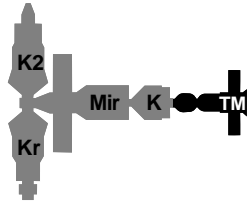

Kvant 2
Mir • Kvant • Soyuz-TM 10
Kristall

August 9-17, 1990

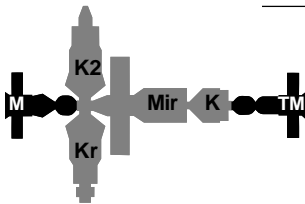

Kvant 2
Progress-M 4 • Mir • Kvant • Soyuz-TM 10
Kristall

August 17-September 17, 1990

Integrating Kristall and emergency drills. The Vulkans linked Kristall's attitude control system to the Mir complex on August 28. On August 30 they practiced dealing with emergency situations which might arise in the expanded Mir complex. Between August 22 and September 11, Progress-M 4 boosted the complex to a mean altitude of 390 km.

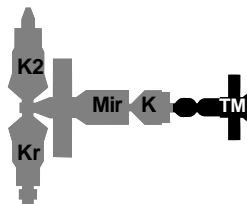

Kvant 2
Mir • Kvant • Soyuz-TM 10
Kristall

September 17-29, 1990

Plasma experiment. Strekalov and Manakov installed a device for producing plasma on Progress-M 4's docking unit before casting off the spacecraft. For three days it flew formation with the station, releasing plasma for the Vulkans to observe and record.

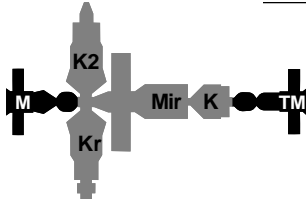

September 29–November 28, 1990

Kvant 2
Progress-M 5 • Mir • Kvant • Soyuz-TM 10
Kristall

Progress-M 5 and Raduga. Progress-M 5 carried television equipment for the upcoming joint Soviet-Japanese mission. It was also the first Progress-M equipped with a Raduga return capsule. On October 1 Soyuz-TM 10's main engine pushed Mir to a mean altitude of 397 km. The KAP-350 and Priroda 5 cameras were used as part of the Makhichevan-90 Earth resources observation program, which studied the region between the Black and Caspian seas.

EVA—Kvant 2 EVA hatch damage more severe than expected. The Soviets postponed the EVA several days after Strekalov came down with a cold. On October 29 the cosmonauts exited Mir through the Kvant 2 hatch and removed thermal insulation. They found that the hatch was beyond their ability to repair. They attached a device to the hatch to allow it to close properly.

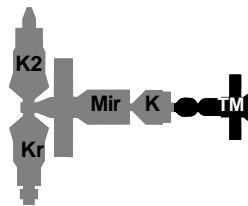

November 28–December 4, 1990

Kvant 2
Mir • Kvant • Soyuz-TM 10
Kristall

2.9.3.9 Mir Principal Expedition 8

Viktor Afanaseyev, Musa Manarov
 Crew code name—Derbent
Soyuz-TM 11, December 2, 1990–May 26, 1991
 175 days in space

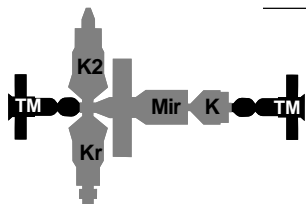

December 4–10, 1990

Kvant 2
Soyuz-TM 11 • Mir • Kvant • Soyuz-TM 10
Kristall

Soyuz-TM 11 arrives. Viktor Afanaseyev, Musa Manarov (on his second Mir visit), and Japanese television journalist Toyohiro Akiyama were welcomed aboard Mir by the Vulcans. Akiyama's network, the Tokyo Broadcasting System (TBS), paid for the flight. The Soviets called this their first commercial spaceflight and claimed to have earned \$14 million. The journalist was scheduled to make one 10-min TV broadcast and two 20-min radio broadcasts each day. Electrical power and video and TV system incompatibilities forced the Japanese to make extensive use of converters. His equipment, which weighed about 170 kg, was delivered by Progress-M spacecraft and set up in advance by Manakov and Strekalov. On December 5 Akiyama's couch was transferred to Soyuz-TM 10. On December 8 Manakov and Strekalov commenced loading Soyuz-TM 10's descent module with film and experiment results. TBS broadcast Akiyama's landing live from Kazakhstan.

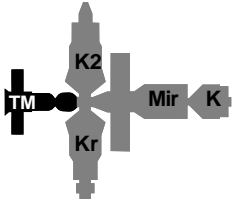

Kvant 2
Soyuz-TM 11 • Mir • Kvant
Kristall

December 10, 1990-January 16, 1991

First EVA—hinge repair. On January 4 Afanaseyev and Manarov prepared their spacesuits for an EVA to repair the Kristall EVA hatch hinge damaged by Solovyov and Balandin in July 1990. They suited up and practiced in the Kvant 2 airlock. On January 7 the Derbents opened Kvant 2's EVA hatch and clambered outside. They repaired the damaged hinge, tested their handiwork by closing and sealing the hatch, then reopened the hatch and went about other tasks. These included transfer outside the station of equipment scheduled for installation on later EVAs. They also removed a TV camera from Kvant 2 for repairs inside the station. The EVA lasted 5 hr, 18 min.

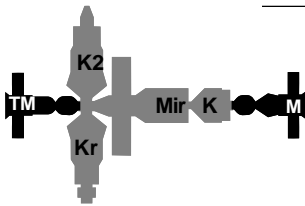

Kvant 2
Soyuz-TM 11 • Mir • Kvant • Progress-M 6
Kristall

January 16-March 15, 1991

Second EVA—boom installation. On January 23 the Derbents opened the newly-repaired hatch and slowly transferred a carton 6 m long to a worksite on the base block. The container held Strela, a folded boom with a pivot mechanism at its base. They attached Strela to supports which originally held the base block's launch faring. The 45-kg boom was meant to play a key role in the transfer of Kristall's twin 500-kg collapsible solar arrays to the sides of Kvant. Maximum boom length was 14 m; maximum capacity, up to 700 kg. The EVA lasted 5 hr, 33 min.

Third EVA—support structures. On January 26 the Derbents spent 6 hr, 20 min installing support structures on Kvant. They were meant to hold the Kristall solar arrays.

Five years of Mir. February 19 marked the fifth anniversary of Mir's launch. The Derbents spent February working with materials science apparatus in Kristall. They used the Pion unit to study the effects on semiconductor production of changing patterns of microacceleration aboard Mir caused by operation of its equipment. On March 7 the cosmonauts extended a pole bearing a magnetic sensor through a Mir scientific airlock as part of the Diagramma program to characterize the environment outside the station.

Observing the Gulf War. Afanaseyev and Manarov could easily see evidence of war as they passed over the Persian Gulf. They sent back TV images of oil spills, smoke pouring from a coastal town, and fires.

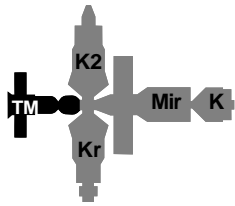

Kvant 2
Soyuz-TM 11 • Mir • Kvant
Kristall

March 15-26, 1991

Progress-M 7 near-miss. On March 21 Progress-M 7 broke off its approach 500 m from the aft docking port. On March 23 the craft made a second approach, but 20 m from the rear port a controller in the TsUP detected a “catastrophic error” and broke off the approach. Progress-M 7 passed within 5 to 7 m of the station, narrowly avoiding antennas and solar arrays.¹²⁵

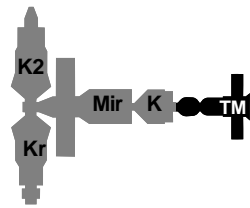

Kvant 2
Mir • Kvant • Soyuz-TM 11
Kristall

March 26-28, 1991

Kurs antenna problem diagnosed. Afanaseyev and Manarov undocked Soyuz-TM 11 from the front port and transferred it to the aft. During approach to the aft port, they used Kurs, rather than carrying out the transfer under manual control, as was typical. They found that their spacecraft mimicked Progress-M 7’s behavior, veering away from the docking port. The cosmonauts completed a normal manual docking at the aft port, having determined that the problem was in Mir’s aft port Kurs antenna. Subsequently, Progress-M 7 docked at Mir’s front port. If it had failed to dock, the cosmonauts might have had to draw on a 1–mo reserve of emergency supplies while a standby Progress was readied.

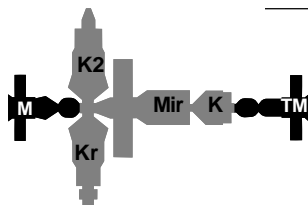

Kvant 2
Progress-M 7 • Mir • Kvant • Soyuz-TM 11
Kristall

March 28-May 6, 1991

Fourth EVA. On April 25 Manarov filmed the damaged Kvant Kurs antenna. He reported that one of its dishes was missing. During the EVA the cosmonauts also replaced the camera they had removed from Kvant 2 on their first EVA and repaired inside Mir. The EVA lasted 3 hr, 34 min.

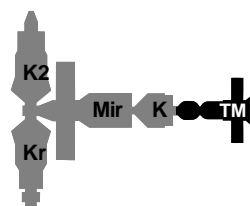

Kvant 2
Mir • Kvant • Soyuz-TM 11
Kristall

May 6-20, 1991

2.9.3.10 Mir Principal Expedition 9

Anatoli Artsebarski, Sergei Krikalev

Crew code name—Ozon

Soyuz-TM 12, May 18-October 11, 1991

145 days in space

See Mir Principal Expedition 10 note.

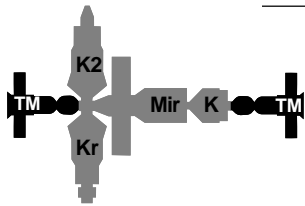

May 20-May 26, 1991

Kvant 2
Soyuz-TM 12 • Mir • Kvant • Soyuz-TM 11
Kristall

Arrival of Soyuz-TM 12. The Derbents welcomed aboard Mir Anatoli Artsebarski, Sergei Krikalev (on his second visit to the station), and British cosmonaut-researcher Helen Sharman, who was aboard as part of Project Juno, a cooperative venture partly sponsored by British private enterprise. Sharman's experimental program, which was designed by the Soviets, leaned heavily toward life sciences. A bag of 250,000 pansy seeds was placed in the Kvant 2 EVA airlock, a compartment not as protected from cosmic radiation as other Mir compartments. Sharman also contacted nine British schools by radio and conducted high-temperature superconductor experiments with the Elektropograph-7K device. Sharman commented that she had difficulty finding equipment on Mir as there was a great deal more equipment than in the trainer in the cosmonaut city of Zvezdny Gorodok. Krikalev commented that, while Mir had more modules than it had had the first time he lived on board, it did not seem less crowded, as it contained more equipment. Krikalev also noted that some of the materials making up the station's exterior had faded and lost color, but that this had had no impact on the station's operation.¹²⁶

Solar power problems. During a communication session with a British girls' school on May 21, Sharman commented that Mir was experiencing solar array problems because of the station's changing orientation. Late that day the level of background noise on the station suddenly fell from the customary 75 decibels as fans, circulating pumps, and other equipment shut down. The lights began to fade. A computer in the orientation system had failed, preventing the solar arrays from tracking on the Sun, and causing Mir to drain its batteries. Sharman stated that Afanaseyev and Manarov told her such power problems had occurred before. When it reentered sunlight, the station was turned to recharge its batteries.¹²⁷

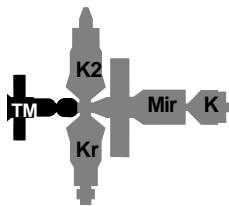

May 26-28, 1991

Kvant 2
Soyuz-TM 12 • Mir • Kvant
Kristall

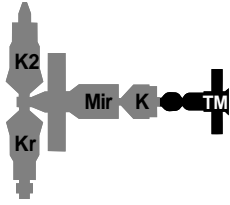

Kvant 2
Mir • Kvant • Soyuz-TM 12
Kristall

May 28-June 1, 1991

Moving Soyuz-TM 12. The Ozons needed to move their spacecraft to Mir's aft port to make way for Progress-M 8, which could not dock with the rear port because of the damage to the Kurs approach system antenna there. The move required 42 min.

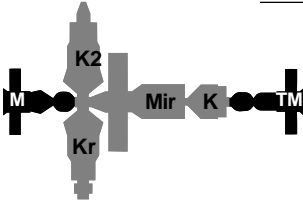

Kvant 2
Progress-M 8 • Mir • Kvant • Soyuz-TM 12
Kristall

June 1- August 15, 1991

MAK-1. The cosmonauts released the small MAK-1 satellite from the Mir base block's experiment airlock on June 17. It was designed to study Earth's ionosphere. However, a probable power failure prevented its antennas from deploying, and the satellite remained inert.

First EVA—fixing Kurs. On June 24 the Ozons exited the hatch on Kvant 2 and clambered over Mir's hull to the aft end of Kvant, where they removed the damaged Kurs approach system unit and replaced it. They also assembled a prototype thermomechanical joint to be used in the assembly of space structures. The EVA lasted 4 hr, 53 min.

Second EVA—TREK. On June 28 the cosmonauts attached to Mir's hull the TREK instrument, a device for studying cosmic ray superheavy nuclei. The experiment was devised by the University of California and delivered by Progress-M 8. The Ozons used the Strela telescoping boom to move about the station. EVA duration was 3 hr, 24 min.

Third EVA—Preparing for Sofora construction. On July 15 the Ozons used the Strela boom to transfer equipment from the Kvant 2 EVA hatch to the work site on Kvant. They attached two ladders to Kvant to give them handholds, then assembled a platform for Sofora on Kvant. Sofora was to be a 14.5-m girder extending from Kvant. The EVA lasted 5 hr, 56 min.

Fourth EVA—Sofora construction commences. On July 19 Krikalev and Artsebarski installed an automated assembly unit similar to the one Kizim and Solovyov had experimented with on Salyut 7 in 1986. Sofora was also an experimental construction, but the Soviets had plans to attach an attitude control thruster unit to it if it functioned as expected. The thruster unit would augment Mir's attitude control systems. They assembled 3 of 20 segments planned for Sofora before returning to Mir. The EVA lasted 5 hr, 28 min.

Fifth EVA—Sofora construction continues. On July 23 the Ozons added 11 segments to the Sofora girder. The EVA lasted 5 hr, 34 min.

Sixth EVA—Sofora construction completed. On July 27 the cosmonauts added the last six segments to the Sofora girder. They also attached a Soviet flag in a metal frame to the top of the girder. This was not planned in advance; the cosmonauts decided independently to attach the flag. Artsebarski's visor

fogged up from exertion, but Krikalev was able to help him back to the Kvant 2 hatch. EVA duration was 6 hr, 49 min.¹²⁸

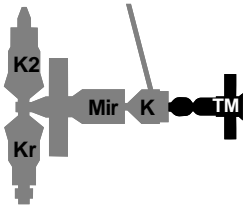

August 15-23, 1991

Kvant 2
Mir • Kvant • Soyuz-TM 12
Kristall

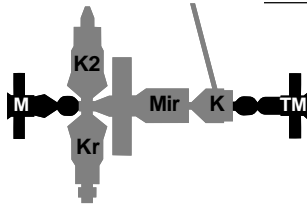

August 23-September 30, 1991

Kvant 2
Progress-M 9 • Mir • Kvant • Soyuz-TM 12
Kristall

Failed coup d'état in Moscow. The coup against Mikhail Gorbachev had little immediate impact on Mir operations. Progress-M 9 was launched as the coup attempt fell apart, on August 21. Boris Belitsky, a Radio Moscow space and science reporter, stated that the TsUP relayed broadcasts of Soviet Central TV (pro-coup) and Russian Radio (anti-coup) to the Ozons. He stated that there were never any plans to abandon the station during the coup, but revealed that such provisions existed in the event of the outbreak of a major war on Earth.¹²⁹

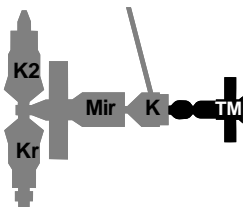

September 30-October 4, 1991

Kvant 2
Mir • Kvant • Soyuz-TM 12
Kristall

2.9.3.11 Mir Principal Expedition 10

Alexandr Volkov, Sergei Krikalev

Crew code name—Donbass

Soyuz-TM 13, October 2, 1991-March 25, 1992

175 days in space

Krikalev remained on board Mir while Artsebarski returned to Earth in Soyuz-TM 12. Volkov arrived on Soyuz-TM 13 to replace Artsebarski. Krikalev's total time in space (Principal Expedition 9 and 10) was 320 days.

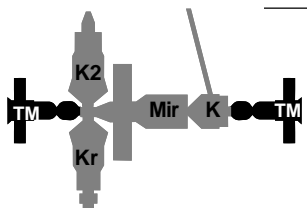

October 4-10, 1991

Kvant 2
Soyuz-TM 13 • Mir • Kvant • Soyuz-TM 12
Kristall

Soyuz-TM 13 arrives. Soyuz-TM 13 carried Austrian cosmonaut-researcher Franz Viehboeck and Kazakh cosmonaut-researcher Toktar Aubakirov. The flight was unusual for carrying no flight engineer. Veteran Russian cosmonaut Alexandr Volkov commanded. The Austrians paid \$7 million to fly Viehboeck

to Mir, and the Kazakh cosmonaut flew partly in an effort to encourage newly-independent Kazakhstan to continue to permit launchings from Baikonur Cosmodrome. The cosmonaut-researchers photographed their respective countries from orbit and conducted the usual range of materials processing and medical experiments. Artsebarski traded places with Volkov and returned to Earth in Soyuz-TM 12.

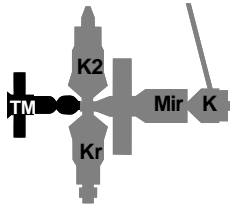

October 10-15, 1991

Kvant 2
Soyuz-TM 13 • Mir • Kvant
Kristall

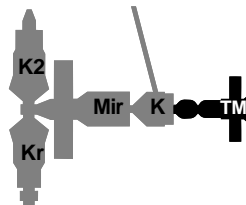

October 15-21, 1991

Kvant 2
Mir • Kvant • Soyuz-TM 13
Kristall

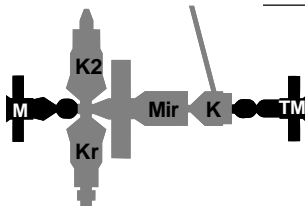

October 21, 1991-January 20, 1992

Kvant 2
Progress-M 10 • Mir • Kvant • Soyuz-TM 13
Kristall

Impact damage. By this date the Mir base block had suffered orbital debris and meteoroid damage on the flat sealing surface of one of its docking rings and on most of its windows.¹³⁰

Progress-M 10 aborts docking. The spacecraft broke off its first docking attempt on October 19 at a distance of 150 m. It successfully docked on October 21.

Cosmos 1897 drifts off station. The Altair/SR satellite drifted to 90° E in the geostationary belt by March. By late April the Soviets had maneuvered it back to 95° E, but by the end of 1991 it had drifted to 77° E and was widely considered inoperative. The other Altair/SR satellite, Cosmos 2054, continued to serve as a communications relay between Russia and Mir.

Diagramma. In October the cosmonauts extended a Diagramma boom from Mir's small airlock to test the atmosphere around the station.

Mir problems. The cosmonauts ended 1991 by replacing storage batteries and conducting ongoing repairs on the complex. At the end of the year total solar array power production was down to 10 kW. In addition, 4 of 6 gyrodynes on Kvant 2 and 1 of 6 gyrodynes on Kvant (5 of Mir's total of 12) had failed.

Progress-M 10 undocking delayed. The spacecraft topped off Mir's propellant tanks on January 13. Undocking planned for January 18 was postponed by a problem with the wiring of Mir's gyrodynes, which affected the station's attitude. When it undocked on January 20, it carried a Raduga return capsule, which was safely recovered.

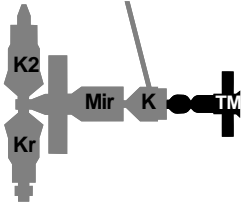

Kvant 2
Mir • Kvant • Soyuz-TM 13
Kristall

January 20-27, 1992

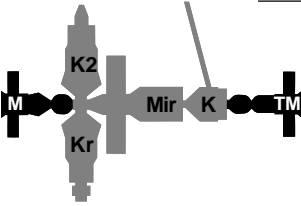

Kvant 2
Progress-M 11 • Mir • Kvant • Soyuz-TM 13
Kristall

January 27-March 13, 1992

Progress-M 11. The spacecraft carried a repair kit for the station's gyrodynes. During its approach to the station, flight controllers in the TsUP were on strike for higher rates of pay, but they did not interfere with the docking. Progress-M 11 boosted the complex into a 413 km by 380 km orbit before undocking.

Communication cutbacks. In January 1991 the fleet of ocean-going tracking ships in place since the early 1960s was phased out of Mir operations to save funds. Some of the ships continued to operate to support unmanned missions, and could step in as a backup when needed to support Mir. By mid-February, Mir was spending up to 9 hrs each day out of touch with the TsUP because of tracking system cutbacks.¹³¹

EVA. On February 20 Volkov and Krikalev opened the Kvant 2 EVA hatch for what would be Krikalev's seventh EVA in less than a year. The heat exchanger on Volkov's Orlan-DMA spacesuit failed, forcing a hasty revision of the EVA plans. Volkov remained near the hatch, so could not operate the Strela boom to move Krikalev to the prime work site on Kvant. Volkov assisted in installation of space exposure experiments near the hatch, then Krikalev clambered down Kvant 2 and over the hull to Kvant. He disassembled equipment used in building the Sofora girder in July 1991, then cleaned the cameras on Kvant. Finally, he collected samples of solar cells added to the third (top) array on the base block in 1988. The EVA lasted 4 hr, 12 min.

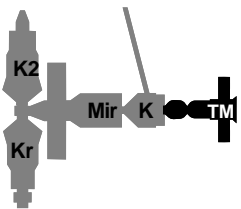

Kvant 2
Mir • Kvant • Soyuz-TM 13
Kristall

March 13-14, 1992

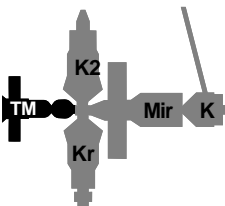

Kvant 2
Soyuz-TM 13 • Mir • Kvant
Kristall

March 14-19, 1992

2.9.3.12 Mir Principal Expedition 11

Alexandr Viktorenko, Alexandr Kaleri
 Crew code name—Vityaz
Soyuz-TM 14, March 17-August 10, 1992
 147 days in space

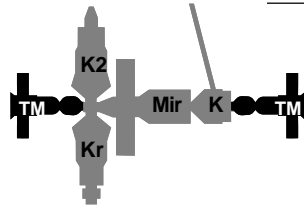

Kvant 2
Soyuz-TM 13 • Mir • Kvant • Soyuz-TM 14
Kristall

March 19-25, 1992

Soyuz-TM 14 arrives . . . Klaus Dietrich Flade became the second German to visit a space station when he reached Mir with the Vityaz crew. The first was Sigmund Jahn of East Germany, who visited Salyut 6 in 1978. Flade conducted 14 German experiments as part of Germany's preparation for participation in the Freedom and Columbus space station projects.

. . . and Krikalev departs. Sergei Krikalev was to have returned to Earth in October 1991, but moves to cut costs had forced modifications to his mission. A Soyuz-TM flight was cancelled, and his replacement, Alexandr Kaleri, was bumped from the Soyuz-TM 13 flight to make way for Toktar Aubakirov on the Soyuz-TM 13 flight. Krikalev had to remain on board Mir. Western news agencies had reported that Krikalev was stranded on Mir, though this was of course incorrect. NPO Energia paid Kazakh authorities \$15,000 in rents for airports and helicopters during the recovery operation.

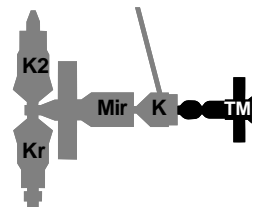

Kvant 2
Mir • Kvant • Soyuz-TM 14
Kristall

March 25-April 21, 1992

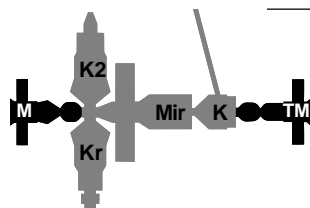

Kvant 2
Progress-M 12 • Mir • Kvant • Soyuz-TM 14
Kristall

April 21-June 27, 1992

Mir sleepy. During this period, NPO Energia representative B. Chertok stated that the Mir station, by this time 6 years old, could no longer be mothballed. It would, he stated, “doze off forever” within 2 months without the attentions of a resident crew.¹³²

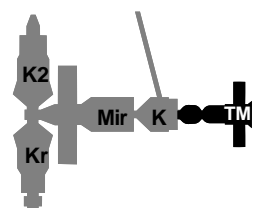

Kvant 2
Mir • Kvant • Soyuz-TM 14
Kristall

June 27-July 4, 1992

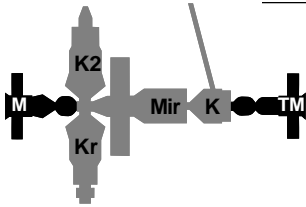

July 4-24, 1992

Kvant 2
Progress-M 13 • Mir • Kvant • Soyuz-TM 14
Kristall

EVA—inspecting gyrodynes. Kvant 2’s gyrodynes were installed on its exterior, within easy reach of the Kvant 2 EVA hatch. The Vityazi’s spent 2 hr, 3 min examining the gyrodynes in anticipation of a future repair and replacement mission.

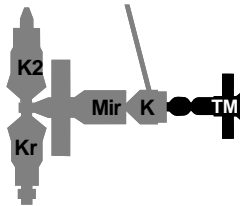

July 24-29, 1992

Kvant 2
Mir • Kvant • Soyuz-TM 14
Kristall

2.9.3.13 Mir Principal Expedition 12

Anatoli Solovyov, Sergei Avdeyev

Crew code name—Rodnik

Soyuz-TM 15, July 27, 1992-February 2, 1993

191 days in space

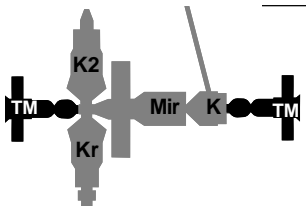

July 29-August 9, 1992

Kvant 2
Soyuz-TM 15 • Mir • Kvant • Soyuz-TM 14
Kristall

Franco-Russian Antares mission. Michel Tognini, passenger aboard Soyuz-TM 15, was the third Frenchman to visit a space station. He conducted ten experiments using 300 kg of equipment delivered by Progress-M flights.

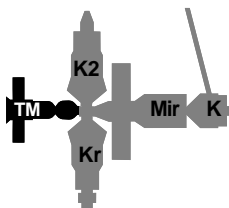

August 9-18, 1992

Kvant 2
Soyuz-TM 15 • Mir • Kvant
Kristall

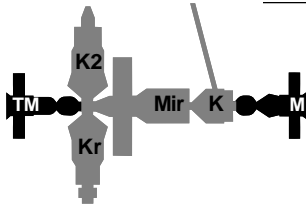

August 18-October 21, 1992

Kvant 2
Soyuz-TM 15 • Mir • Kvant • Progress-M 14
Kristall

Progress-M 14 delivers VDU. The modified Progress-M spacecraft docked at the Kvant port. In place of a tanker compartment, it carried a 700-kg VDU thruster unit designed to be installed atop the Sofora girder mounted on Kvant. The unit was designed to improve Mir's attitude control capabilities. Commands from the TsUP automatically unloaded the VDU unit on September 2.

First EVA—preparing for VDU installation. Avdeyev and Solovyov moved the VDU to the work site and prepared the Sofora girder on September 3. EVA duration was 3 hr, 56 min.

Second EVA—laying a cable. On September 7 the cosmonauts bent Sofora back on a hinge at one-third of its length to make its top more accessible, and laid a control cable along the girder. They also removed the remnants of the Soviet flag placed on the mast during its assembly in 1991. It had been reduced to shreds by UV degradation and orbital debris and meteoroid impacts. EVA duration was 5 hr, 8 min.

Third EVA—VDU installation complete. On September 11 the cosmonauts attached the VDU unit atop the Sofora girder and hoisted it into position by straightening the girder. The EVA lasted 5 hr, 44 min.

Fourth EVA—preparing for Soyuz-TM 16. On September 15 Solovyov and Avdeyev retrieved solar cell and materials samples and moved the Kurs rendezvous antenna on Kristall so it could be used by Soyuz-TM 16.

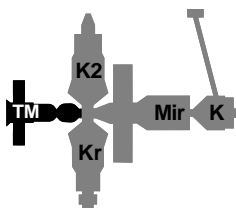

October 21-29, 1992

Kvant 2
Soyuz-TM 15 • Mir • Kvant
Kristall

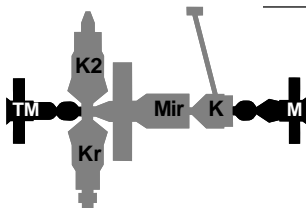

October 29, 1992-January 26, 1993

Kvant 2
Soyuz-TM 15 • Mir • Kvant • Progress-M 15
Kristall

MAK-2 deployed. The cosmonauts released the 16.5-kg satellite from the Mir base block's experiment airlock on November 20. Its purpose was to study Earth's ionosphere.

Near-miss by satellite. The derelict 550-kg Cosmos 1508 satellite, launched by the Soviet Union in 1983, passed within 300 m of Mir on November 8.¹³³

2.9.3.14 Mir Principal Expedition 13

Gennadi Manakov, Alexandr Poleshchuk

Crew code name—Elbrus

Soyuz-TM 16, January 24, 1993-July 22, 1993

178 days in space

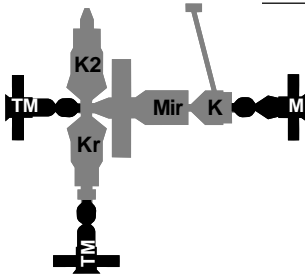

January 26-February 1, 1993

Kvant 2
Soyuz-TM 15 • Mir • Kvant • Progress-M 15
Kristall
Soyuz-TM 16

Soyuz-TM 16 creates a unique Mir configuration. Soyuz-TM 16 docked with the lateral APAS-89 docking unit on Kristall. This tested the unit for future operations. Mission commander Manakov was paying his second visit to Mir. On January 28 the cosmonauts carried out Rezonans tests on the Mir complex, which at this time weighed more than 90 tons (its heaviest ever) and included seven separately launched spacecraft.¹³⁴

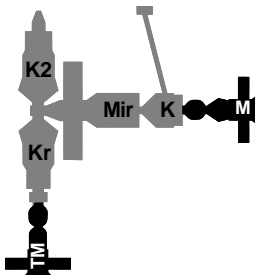

February 1-4, 1993

Kvant 2
Mir • Kvant • Progress-M 15
Kristall
Soyuz-TM 16

Avdeyev and Solovyov return to Earth. The Soyuz-TM 15 descent module lowered to Earth beneath low clouds, touched down, and rolled partway down a hillock. It came to rest 150 m from a frozen marsh.¹³⁵

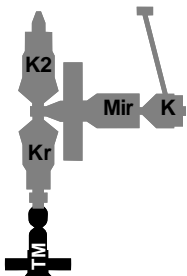

February 4-23, 1993

Kvant 2
Mir • Kvant
Kristall
Soyuz-TM 16

Znamya. On February 4 Progress-M 15 undocked from Mir and backed to a distance of 230 m. The spacecraft fired thrusters to cause it to rotate about its long axis, after which it successfully deployed a 20-m, 40-kg foil reflector called Znamya (“banner”) from its orbital module. It was a test of a future solar reflector/solar sail designed to illuminate and warm regions on the Earth’s surface not in direct sunlight, such as the polar regions in winter. The experiment lasted only 6 min, during which time Progress-M 15 and the nearby Mir complex passed over Europe along a path from Lyon, in southern France, through Prague in the Czech Republic, to Gomel in eastern Belarus. Znamya was sighted in the predawn sky in many places along the path, including

southern France, eastern Poland, and Belarus. Manakov and Poleshchuk observed the test from Mir. Znamya was then cast off. The collapsed, tumbling reflector remained visible from the surface for 24 hr. It was seen as a glittering object over much of Canada.^{136, 137}

Progress-M 15 in teleoperations experiment. After discarding Znamya, Progress-M 15 was controlled by the cosmonauts on Mir at a distance of 200 m. The test lasted 12 min. Progress-M 15 was deorbited by command from the TsUP on February 7.

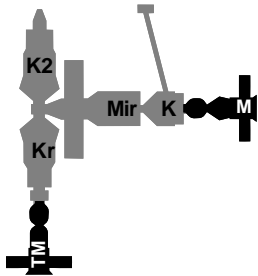

February 23-March 27, 1993

Kvant 2
Mir • Kvant • Progress-M 16
Kristall
Soyuz-TM 16

Progress-M 16 delivers replacement parts. On March 2 Manakov and Poleshchuk replaced Mir's air conditioning unit. They also replaced components in the part of the communication system linking Mir to the Cosmos 2054 Altair/SR satellite. Over the next week the cosmonauts installed new gyrodynes in Kvant 2 and replaced parts in the computers. On March 19 Poleshchuk and Manakov connected the electrical systems of Kvant 2 and Kristall. Soon after, they tested the new gyrodynes in Kvant 2 by moving the complex.

Progress-M 16 controlled from Mir. The cargo craft undocked early on March 26 and backed off to a distance of 70 m under control of the cosmonauts inside Mir. They then commanded Progress-M 16 to approach and dock. The operation was completed within 20 min of initial undocking. Final undocking on March 27 was initiated and controlled in its initial stages by Poleshchuk and Manakov. The TsUP took control for the final stages of the cargo ship's flight and its destructive reentry.

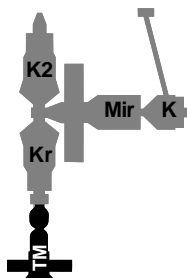

March 27-April 2, 1993

Kvant 2
Mir • Kvant
Kristall
Soyuz-TM 16

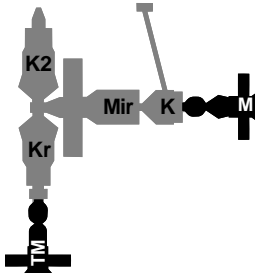

Kvant 2

April 2-May 24, 1993

Mir • Kvant • Progress-M 17

Kristall

Soyuz-TM 16

First EVA—loss of Strela handle. Late on April 19, Poleshchuk and Manakov opened the airlock hatch on Kvant 2 to begin the first of three planned EVAs. Its objective was to install solar array electric drives on the sides of Kvant. These would later receive the collapsible solar arrays from Kristall. Poleshchuk climbed down the length of Kvant 2 to the base of the Strela telescoping boom attached to the base block. Manakov then fixed himself to the end of the boom, at which point Poleshchuk swung the boom to move him to the installation site on Kvant. A container holding one of the electric drives was transferred using the boom. With difficulty the cosmonauts attached the drive to one of the frameworks which had been assembled on opposite sides of Kvant in 1991 by Titov and Manarov. Poleshchuk noticed that one of two control handles for the Strela boom had come off and floated away. A new handle would have to be sent up from Earth before work could continue. The EVA lasted 5 hr, 25 min.

Waiting for the replacement handle. The second EVA, planned for April 23, was cancelled. The cosmonauts carried out routine maintenance on the water regeneration, electricity supply, and onboard computer systems. They also conducted Rezonans tests.

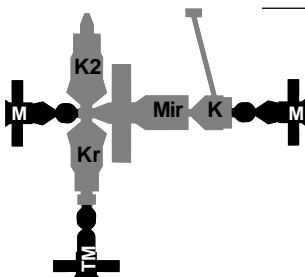

Kvant 2

May 24-July 3, 1993

Progress-M 18 • Mir • Kvant • Progress-M 17

Kristall

Soyuz-TM 16

Second EVA—solar array drive installation completed. Progress-M 18's docking marked the first time a Soviet station was attended by two Progress craft at the same time. In addition to the replacement handle for the telescoping boom, Progress M-18 delivered replacement water pumps for the thermal control system and computer parts. On June 18 Poleshchuk and Manakov exited the station and repaired the boom, then installed the second solar array electric drive. They completed their EVA tasks by televising images of Mir's exterior.

2.9.3.15 Mir Principal Expedition 14

Vasili Tsibliyev, Alexandr Serebrov

Crew code name—Sirius

Soyuz-TM 17, July 1, 1993-January 14, 1994

198 days in space

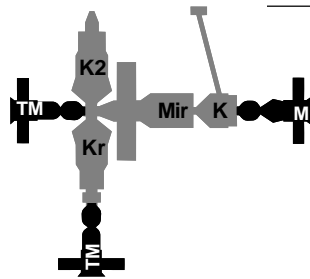

Kvant 2
Soyuz-TM 17 • Mir • Kvant • Progress-M 17
Kristall
Soyuz-TM 16

July 3-22, 1993

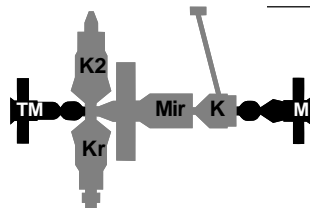

Kvant 2
Soyuz-TM 17 • Mir • Kvant • Progress-M 17
Kristall

July 22-August 10, 1993

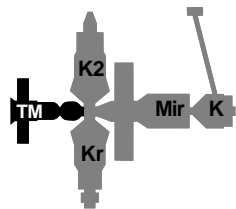

Kvant 2
Soyuz-TM 17 • Mir • Kvant
Kristall

August 10-13, 1993

Perseids peak. The night of August 12-13, the Perseid meteor shower peaked. The Perseids occur every year at this time, but in 1993 an unusually high peak was predicted. Because of this, the U.S. delayed launch of the Space Shuttle Discovery, which was scheduled to be in orbit at this time. The Sirius crew continued to work aboard Mir, but Russia took precautions: planes and helicopters stood by for the possible emergency return of Soyuz-TM 17. During the shower, the cosmonauts mounted an around-the-clock watch, and observed about 240 meteoroids burning up in the atmosphere beneath Mir.¹³⁸ They also noted ten window impacts, which produced craters from 1.5 to 4 mm across. Mir impact sensors noted a particle flux of up to 2000 times the normal mean rate during the Perseid shower. Mir sustained no readily apparent consequential damage from the meteoroids, but the Russians decided to mount EVAs to inspect Mir's exterior nonetheless.

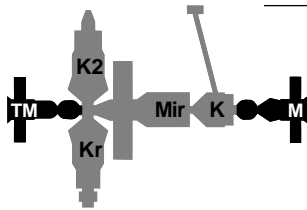

August 13-October 12, 1993

Kvant 2
Soyuz-TM 17 • Mir • Kvant • Progress-M 19
Kristall

First EVA—Rapana girder. The Sirius cosmonauts spent 4 hr, 18 min outside Mir assembling the Rapana girder on top of Kvant on September 16. This was a girder assembly experiment with implications for Mir 2 space station development.

Second EVA—Rapana girder. Tsibliyev and Serebrov spent 3 hr, 13 min completing assembly of Rapana on September 20 (figure 2-17).

Third EVA—Mir inspection. On September 28 the Sirius cosmonauts spent 1 hr, 52 min carrying out miscellaneous tasks and inspecting Mir’s exterior in the first phase of the Panorama program. They spotted a 5-mm hole through one of the solar arrays. The hole was surrounded by an area of cracks several cm across. The cosmonauts were unable to determine if a Perseid meteoroid was the impactor.¹³⁹

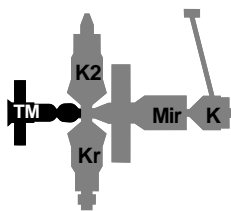

October 12-13, 1993

Kvant 2
Soyuz-TM 17 • Mir • Kvant
Kristall

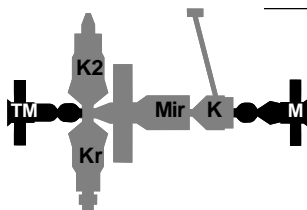

October 13-November 21, 1993

Kvant 2
Soyuz-TM 17 • Mir • Kvant • Progress-M 20
Kristall

Fifth EVA—Mir inspection. The cosmonauts spent 38 min conducting the Panorama inspection of Mir and performing miscellaneous tasks on October 22.

Sixth EVA—Mir inspection. The Sirius cosmonauts spent 4 hrs on October 29 inspecting Mir as part of the Panorama program and conducting miscellaneous tasks. By the end of Panorama they had inspected the entire skin of Mir. Panorama revealed many small impact sites on Mir, though no hull penetrations. During one of their EVAs, a piece of metal of indeterminate origin drifted past the working cosmonauts.¹⁴⁰

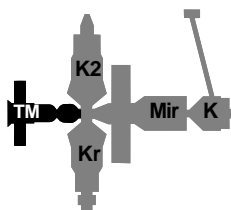

November 21, 1993-January 10, 1994

Kvant 2
Soyuz-TM 17 • Mir • Kvant
Kristall

2.9.3.16 Mir Principal Expedition 15

Viktor Afanaseyev, Yuri Usachyov, Valeri Polyakov

Crew code name—Derbent

Soyuz-TM 18, January 8-July 9, 1994

186 days in space

Valeri Polyakov remained aboard with the Mir Principal Expedition 16 crew. Plans are for him to live aboard Mir for 15 months.

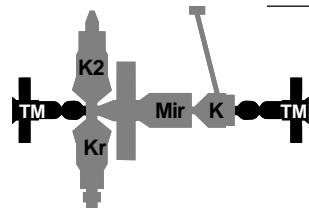

Kvant 2
Soyuz-TM 17 • Mir • Kvant • Soyuz-TM 18
Kristall

January 10-14, 1994

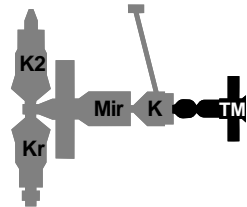

Kvant 2
Mir • Kvant • Soyuz-TM 18
Kristall

January 14-24, 1994

Soyuz-TM 17 recontact. Soyuz-TM 17 struck Mir during the customary inspection fly-around prior to deorbit burn. For details see section 1.13.3. Tsibliyev and Serebrov were conducting proximity operations with Mir. Among other things, they were photographing a NASA JSC-built docking target they had installed during one of their EVAs. They were unable to arrest Soyuz-TM 17's forward movement because of an improperly set switch, and so struck Kristall two glancing blows with its descent module. The blows temporarily disabled Mir's orientation system. Masterful piloting by Tsibliyev prevented Soyuz-TM 17 from striking Mir's antennas and solar arrays. After the incident, the Sirius cosmonauts and ground controllers checked over Soyuz-TM 17, while the Derbents on Mir checked over Kristall. They found no damage. Normal Mir operations resumed, and Soyuz-TM 17 made a normal reentry.^{141, 142}

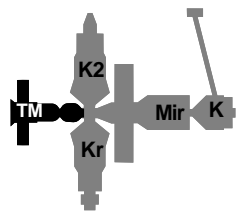

Kvant 2
Soyuz-TM 18 • Mir • Kvant
Kristall

January 24-30, 1994

Kristall inspection. Afanaseyev, Usachov, and Polyakov examined Kristall when they repositioned their spacecraft at the Mir forward port. They detected no damage from the Soyuz-TM 17 recontact.

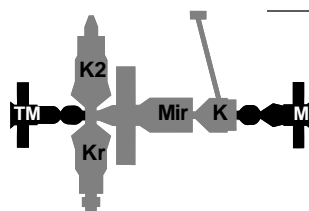

Kvant 2
Soyuz-TM 18 • Mir • Kvant • Progress-M 21
Kristall

January 30-March 23, 1994

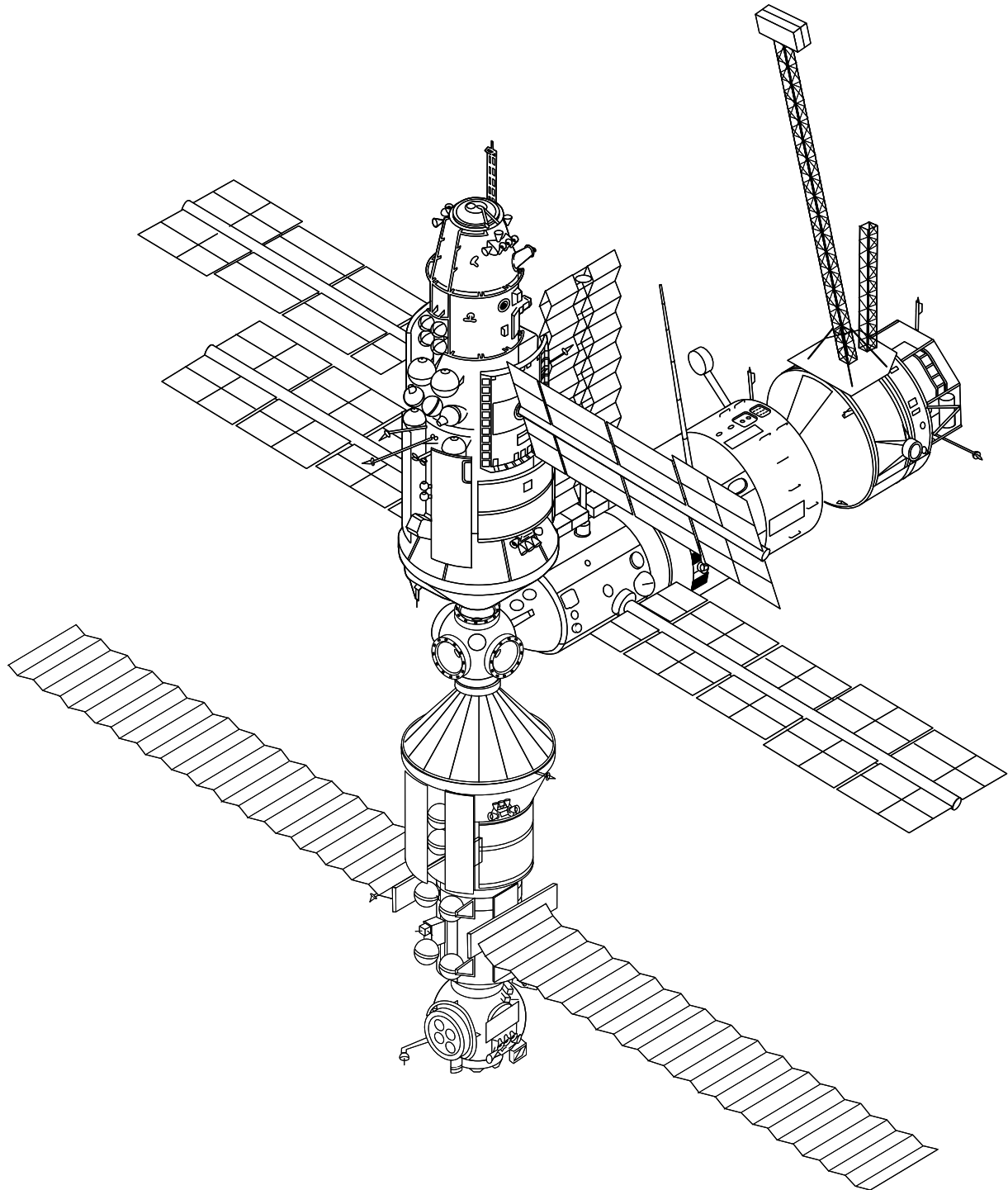
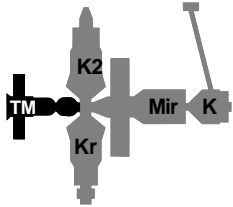
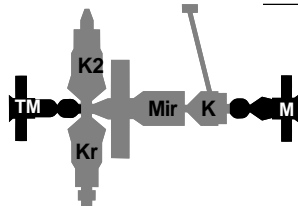

Figure 2-17. Mir base block, Kvant, Kvant 2, and Kristall (1994). Note the Sofora boom and VDU and the Rapana girder attached to the top of Kvant, the Strela boom attached to the side of the base block, and the support on the side of the Kvant module. A matching support is attached to Kvant's other side, out of view. Eventually Kristall's two solar arrays will be relocated to these supports. Soyuz-TM and Progress spacecraft are omitted for clarity.



March 23-24, 1994

Kvant 2
Soyuz-TM 18 • Mir • Kvant
Kristall



March 24-May 23, 1994

Kvant 2
Soyuz-TM 18 • Mir • Kvant • Progress-M 22
Kristall

Progress-M 22 delayed. Launch of the thirty-ninth Progress mission to Mir was delayed to March 22 from March 19 by heavy snowfall at Baikonur Cosmodrome. The rails used to transport Progress-M 22 to its launch pad were covered in snowdrifts up to 7 m deep, so the spacecraft and booster could not be moved from their assembly building.

Mir/Freja electron beam tests. The week of March 28, Mir cosmonauts fired an electron beam gun at the Swedish Freja plasma and magnetospheric physics satellite to study space plasmas and Earth's magnetosphere. At the time Mir was 383 km above the Pacific, south of Alaska, while the 214-kg Freja satellite was 1770 km above the southeast Alaskan coast. A Canadian ground station monitored the test, which resembled one conducted on the STS-45 Space Shuttle mission (March 24-April 2, 1992).

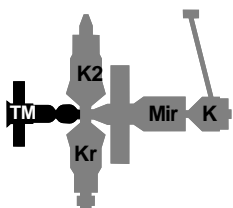

May 23-24, 1994

Kvant 2
Soyuz-TM 18 • Mir • Kvant
Kristall

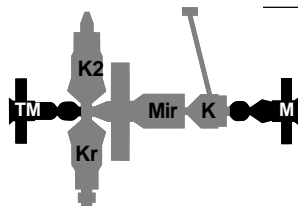

May 24-July 2, 1994

Kvant 2
Soyuz-TM 18 • Mir • Kvant • Progress-M 23
Kristall

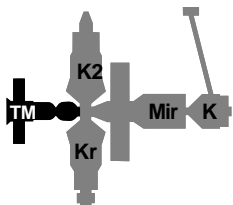

July 2-3, 1994

Kvant 2
Soyuz-TM 18 • Mir • Kvant
Kristall

2.9.3.17 Mir Principal Expedition 16

Yuri Malenchenko, Talgat Musabayev, Valeri Polyakov

Crew code name—Agat

Soyuz-TM 19, July 1-November 4, 1994

Valeri Polyakov arrived on Mir with the Principal Expedition 15 crew. He is scheduled to return to Earth with the Principal Expedition 17 crew in Soyuz-TM 20 in March 1995.

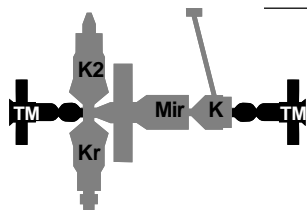

July 3-9, 1994

Kvant 2
Soyuz-TM 18 • Mir • Kvant • Soyuz-TM 19
Kristall

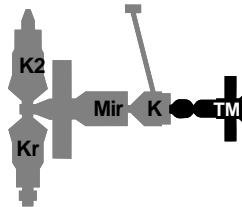

July 9-September 2, 1994

Kvant 2
Mir • Kvant • Soyuz-TM 19
Kristall

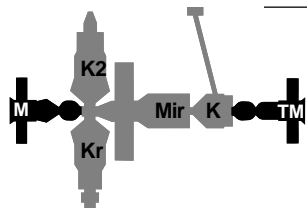

September 2-October 4, 1994

Kvant 2
Progress-M 24 • Mir • Kvant • Soyuz-TM 19
Kristall

Progress-M 24 problems. Progress-M 24's first automatic docking attempt failed on August 27. During the second attempt, on August 30, Progress-M 24 bumped into Mir's forward longitudinal port two to four times at low speed, then drifted away. The Agat crew was running low on supplies, so the Russians gave consideration to mothballing Mir in late September in the event Progress-M 24 could not dock. Ground controllers stated that the station had sufficient propellant to operate in unmanned mode for 4 months. On September 2 Malenchenko took manual control of Progress-M 24 using a control panel on Mir. A TV on Mir displayed an image of the station's front port transmitted from cameras on Progress-M 24; the same image appeared on screens in the TsUP. In an impressive demonstration of remote piloting, Malenchenko docked Progress-M 24 without additional incident. The technique had been tested using Progress-M 15 and Progress-M 16 during Principal Expedition 13 (1993). For additional details, see 1.11.3.

First EVA—many tasks. Malenchenko and Musabayev opened the Kvant 2 EVA airlock outer hatch on September 9 to begin humanity's 100th spacewalk. During the spacewalk, which lasted 5 hr, 4 min, they inspected the docking port struck by Progress-M 24—it proved to be undamaged—and mended a thermal blanket torn when Soyuz-TM 17 struck the station on January 14. They also prepared equipment for moving the Kristall solar arrays to Kvant, and affixed test materials to Mir's exterior.

Second EVA—solar array transfer preparations. On September 14 cosmonauts Musabayev and Malenchenko carried out assembly work connected with the ongoing effort to move Kristall's solar arrays to supports on Kvant. They also inspected the Sofora girder. The EVA lasted 6 hr, 1 min.

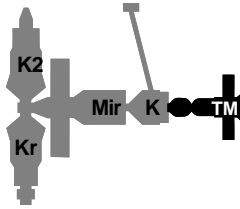

Kvant 2
Mir • Kvant • Soyuz-TM 19
Kristall

October 4-6, 1994

2.9.3.18 Mir Principal Expedition 17

Alexandr Viktorenko, Yelena Kondakova, Valeri Polyakov

Crew code name—Vityaz

Soyuz-TM 20, October 3, 1994-

Polyakov was launched on Soyuz-TM 18 on January 8, 1994. He is scheduled to return to Earth with Viktorenko and Kondakova in March 1995, after more than 420 days in space.

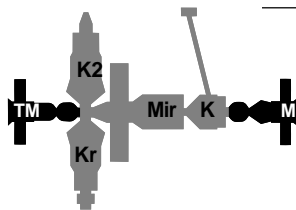

Kvant 2
Soyuz-TM 20 • Mir • Kvant • Soyuz-TM 19
Kristall

October 6-November 4, 1994

Euromir 94 begins. Viktorenko was on his fourth visit to Mir. During final approach, Soyuz-TM 20 yawed unexpectedly. He assumed manual control and completed docking without incident. Kondakova, the mission rookie, was the third Russian female cosmonaut and the first female to take part in a long-duration flight. They were accompanied by ESA astronaut Ulf Merbold, a physicist and veteran of two U.S. Space Shuttle missions. The month-long Euromir 94 experiment program was considered a precursor to the ESA Columbus module planned for the joint U.S.-Russia-ESA-Japan-Canada space station. Merbold's program was planned rapidly, final agreement between ESA and Russian having been concluded in November 1992. It was also constrained by funding limitations—ESA budgeted only about \$60 million for Euromir 94. Because of these limitations, Merbold relied heavily on equipment left on Mir by earlier French, Austrian, and German visitors to the station, as well as the Czech-built CSK-1 materials processing furnace. He also used equipment delivered by Progress-M 24 and Soyuz-TM 20. Merbold's experiment program included 23 life sciences, 4 materials sciences, and 3 technology experiments. The mission is to be followed by the 135-day Euromir 95 mission, scheduled to start in August 1995.

Power shortage and materials processing furnace problems. On October 11 the six cosmonauts aboard Mir were unable to activate a video camera and TV lights while recharging Soyuz-TM 20's batteries. A short circuit had disabled the computer which guided Mir's solar arrays, forcing the station to drain its batteries. The cosmonauts used reaction control thrusters on the Soyuz-TM spacecraft docked to the station to orient it so its solar arrays would point toward the Sun, and switched on a backup computer. Normal conditions

were restored by October 15. According to Yuri Antoshechkin, Deputy Flight Director for Mir Systems, speaking in December at JSC, the shortage afflicted only the Mir core module. Antoshechkin stated through an interpreter that unspecified minor crew error, coupled with a long period out of contact with monitors in the TsUP (caused by Altair/SR relay satellite “prophylactic work”) during a crew sleep period, contributed to the base block discharging its batteries unnoticed, and that an automatic alarm awakened the crew when the power shortage reached a critical level.¹⁴³ Ground teams rescheduled Merbold’s experiments to allow completion of those interrupted by the power problems, and moved experiments using large amounts of electricity to the end of Merbold’s stay. In addition, the Czech-built CSK-1 furnace malfunctioned, forcing postponement of five of Merbold’s experiments until after his return to Earth.

Testing Mir’s Kurs System. On November 3 Malenchenko, Musabayev, and Merbold undocked in Soyuz-TM 19 and withdrew to a distance of 190 m. They then activated its Kurs system, which successfully guided the spacecraft to an automatic docking with Mir’s aft port. The cosmonauts then went back into Mir. The test was a response to the Progress-M 24 docking problems. If it had failed, the Soyuz-TM 19 cosmonauts would have made an emergency return to Earth.

Two European space travelers. The Space Shuttle Atlantis lifted off from Kennedy Space Center on an 11-day atmospheric research mission on November 3. French astronaut Jean-Francois Clervoy was aboard as a mission specialist. In remarks made after Atlantis’ launch, ESA Director-General Jean-Marie Luton stated that there was “a French astronaut flying on an American Space Shuttle to perform experiments from U.S., French, German, and Belgian scientists....Meanwhile, on Russia’s Mir space station, ESA astronaut Ulf Merbold is completing a month-long mission, the longest in European space-flight. By the end of the decade, this level of cooperation will be routine aboard the international space station.”¹⁴⁴

Euromir 94 ends. On November 4 Merbold again squeezed into the Soyuz-TM 19 descent module, this time with 16 kg of the life sciences samples he collected during his stay on the station. Additional samples—including materials processing samples to be produced when the Principal Expedition 17 cosmonauts carry out the experiments Merbold was to have conducted during his stay—may be returned to Earth by Space Shuttle Atlantis in mid-1995. Soyuz-TM 19 undocking, deorbit burn, reentry, and landing occurred without significant incident.

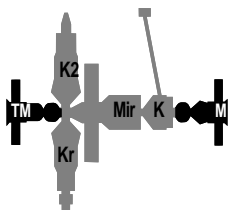

Kvant 2
Soyuz-TM 20 • Mir • Kvant
Kristall

November 4-13, 1994

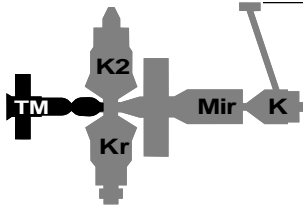

November 13-

Kvant 2
Soyuz-TM 20 • Mir • Kvant • Progress-M 25
Kristall

Progress-M 25 arrives. Viktorenko stood by at the remote control panel on Mir during approach, but manual intervention was unnecessary. Polyakov, veteran of the Progress-M 24 problems, called Progress-M 25 “an ideal freighter.” Among other cargoes, Progress-M 25 delivered replacement parts for the failed CSK-1 materials processing furnace.¹⁴⁵

50,000 orbits. On November 18 the Mir base block completed its 50,000th orbit of the Earth, having covered about 1.9 billion km since launch on February 20, 1986.¹⁴⁶

2.10 References for Part 2

1. Konstantin Tsiolkovskii, *Beyond the Planet Earth*, Pergamon Press, 1960, pp. 8-10.
2. Christian Lardier, "Proton Celebrates its 25th Anniversary," *Aviation Magazine International*, No. 1022, February 15-30, 1991, pp. 53-55.
3. I. B. Afanasyev, "Unknown Spacecraft (From the History of the Soviet Space Program)," *What's New in Life, Science, and Technology: Space Program and Astronomy Series*, No. 12, December 1991. Translated in *JPRS Report, Science & Technology, Central Eurasia: Space*, October 5, 1993 (JPRS-USP-93-005), p. 6.
4. Dmitri Payson, "Without the Secret Stamp: Salyut and Star Wars," *Rossiskiy Vesti*, November 21, 1992, p. 4. Translated in *JPRS Report, Science & Technology, Central Eurasia: Space*, March 25, 1993 (JPRS-USP-93-001), p. 67.
5. Payson, March 25, 1993, p. 67.
6. Afanasyev, p. 18.
7. Afanasyev, p. 19.
8. Dmitri Payson, "We'll Build a Space Station for a Piece of Bread," *Rossiskiy Vesti*, June 1, 1993, p. 8. Translated in *JPRS Report, Science & Technology, Central Eurasia: Space*, June 28, 1993 (JPRS-USP-93-003), p. 12.
9. Payson, March 25, 1993, p. 67.
10. Afanasyev, p. 20.
11. Payson, June 28, 1993, p. 12.
12. Andrei Vaganov, "A Project: We May Still the Sky [*sic*] in Diamonds," *Nezavisimaya Gazeta*, September 17, 1992, p. 6. Translated in *JPRS Report, Science & Technology, Central Eurasia: Space*, November 17, 1992 (JPRS-USP-92-006), p. 19.
13. Afanasyev, p. 22.
14. *Buyer's Guide: Almaz Radar Remote Sensing Satellite*, Space Commerce Corporation, not dated (c. 1990), p. 2.
15. Afanasyev, pp. 22-23.
16. Vaganov, p. 19.
17. "Despite Terrestrial Difficulties," *Vechernaya Moskva*, August 2, 1993, p. 7. Translated in *JPRS Report, Science & Technology, Central Eurasia: Space*, October 5, 1993 (JPRS-USP-93-005), pp. 13-14.
18. David S. F. Portree, *Thirty Years Together: A Chronology of U.S.-Soviet Space Cooperation*, NASA CR-185707, February 1993, p. 19.
19. Letter, Christopher C. Kraft, Director, NASA Johnson Space Center, to John F. Yardley, NASA Associate Director of Manned Space Flight, January 13, 1975.
20. "Record of NASA/Soviet Academy Discussions, October 19-22, 1976," NASA Internal Document, November 1976.
21. "Agreement Between the U.S.S.R. Academy of Sciences and the National Aeronautics and Space Administration of the U.S.A. on Cooperation in the Area of Manned Space Flight," May 11, 1977.
22. Interviews, David S. F. Portree with Clarke Covington, June 13 and 28, 1994.
23. Nicholas Johnson, *Handbook of Soviet Manned Space Flight*, Univelt, 1980, pp. 224-225.
24. Payson, March 25, 1993, p. 20.
25. Boris Petrov, "Orbital Stations," *Nauka i Zhian*, April 3, 1973. Translated in *Spaceflight*, No. 8, August 1973, p. 290. Translation supplied by Soviet Novosti Press Agency.
26. Neville Kidger, "Almaz: A Diamond Out of Darkness," *Spaceflight*, March 1994, p. 87.
27. Afanasyev, p. 20.
28. Afanasyev, p. 19.
29. Johnson, 1980, p. 302, 304.
30. Afanasyev, p. 19.
31. K. P. Feoktistov, "Scientific Orbital Complex," *What's New in Life, Science, and Technology: Space Program and Astronomy Series*, No. 3, 1980, pp. 1-63. Translated in *JPRS L/9145, USSR Report*, June 17, 1980, p. 4.
32. Charles Sheldon, *Soviet Space Programs, 1971-1975*, Vol. 1, Library of Congress, 1976, p. 209.
33. Sheldon, pp. 208, 210.
34. Johnson, 1980, pp. 249-250.
35. Feoktistov, p. 19.
36. Feoktistov, pp. 17, 32.
37. Feoktistov, pp. 17-18.
38. Johnson, 1980, p. 259.
39. Johnson, 1980, pp. 336-337.
40. Gordon Hooper, "Missions to Salyut 6," *Spaceflight*, June 1978, pp. 230-232.
41. Interview, David S. F. Portree with Sergei Krikalev, February 28, 1994.
42. Gordon Hooper, "Missions to Salyut 6," *Spaceflight*, March 1979, pp. 127-129.
43. Johnson, 1980, p. 352.
44. Johnson, 1980, p. 355.
45. Johnson, 1980, p. 362.

46. E. Grigorov and N. Pavlov, "Using Terrestrial Analogs," *Aviatsiya i Kosmonavtika*, No. 11, 1979, pp. 34-35. Translated in *JPRS 75430, USSR Report, Space*, No. 4, April 2, 1980, pp. 3-4.
47. Grigorov and Pavlov, pp. 3-4.
48. Valeri Ryumin, *A Year Away from Earth: A Cosmonaut's Diary*, Molodaya Gvardiya, 1987, pp. 1-207. Translated in *JPRS Report, Science & Technology, USSR: Space*, February 12, 1990 (JPRS-USP-90-002-L), p. 6.
49. Johnson, 1980, p. 365.
50. Ryumin, pp. 8-9.
51. Ryumin, pp. 13-14.
52. Ryumin, p. 15.
53. Johnson, 1980, p. 369-370.
54. N. S. Kardashev, A. I. Savin, M. B. Zakson, A. G. Sokolov, and V. P. Feoktistov, "The First Radio Telescope in Space," *Zemlya i Vselennaya*, No. 4, July-August 1980, pp. 2-9. Translated in *JPRS 76578, USSR Report, Space*, No. 7, October 8, 1980, pp. 1-7.
55. Ryumin, pp. 16-18.
56. Johnson, 1980, pp. 371-372.
57. I. Melenevskiy, "Soft Landing," *TRUD*, March 27, 1980, p. 5. Translated in *JPRS 75678, USSR Report, Space*, No. 5, May 12, 1980, pp. 1-3.
58. Nicholas Johnson, *Soviet Space Programs 1980-1985*, Univelt, 1987, p. 151.
59. Ryumin, p. 32.
60. Ryumin, p. 38.
61. Ryumin, p. 47.
62. Ryumin, p. 48.
63. Ryumin, pp. 48-49.
64. Ryumin, p. 51.
65. "Chronology of Soyuz-T 3 Mission," *JPRS 77488, USSR Report, Space*, No. 9, March 2, 1981, pp. 1-2. Compilation of transcripts of English-language broadcast reports from the Soviet news agency TASS, November 27-December 10, 1980.
66. "Chronology of Soyuz-T 4 Missions," *JPRS 78264, USSR Report, Space*, No. 11, June 10, 1981, pp. 2-4. Compilation of transcripts of English-language broadcast reports from the Soviet news agency TASS, March 19-30, 1981.
67. Nicholas Johnson, *The Soviet Year in Space 1982*, Teledyne Brown Engineering, 1983, p. 27.
68. Pierre Langereux, "New Cosmonauts are Preparing to Man Salyut 6," *Air et Cosmos*, No. 786, November 10, 1979, p. 42. Translated in *JPRS L/8858, USSR Report, Space*, January 9, 1980, pp. 1-3.
69. Pierre Langereux, "Cosmos 1267," *Air et Cosmos*, October 1981, p. 39. Translated in *JPRS L/10523, USSR Report, Space*, May 18, 1982, p. 3.
70. Johnson, 1983, p. 27.
71. Valentin Lebedev, *Diary of a Cosmonaut: 211 Days in Space*, Bantam, 1990, pp. 41, 46.
72. Lebedev, pp. 40-54.
73. Lebedev, pp. 73, 77.
74. Lebedev, pp. 93-94.
75. Lebedev, pp. 117, 119.
76. Lebedev, p. 135.
77. Lebedev, pp. 131-158.
78. Johnson, 1983, p. 28.
79. Lebedev, pp. 169-201.
80. Lebedev, p. 217.
81. James R. Asker, "Soviet Cosmonauts Plan Daily for U.S. Emergency Landings," *Aviation Week & Space Technology*, July 22, 1991, pp. 21-22.
82. Lebedev, pp. 227-228.
83. Nicholas Johnson, *The Soviet Year in Space: 1983*, Teledyne Brown Engineering, 1984, p. 41.
84. David S. F. Portree and Joseph P. Loftus, Jr., *Orbital Debris and Near-Earth Environmental Management: A Chronology*, NASA RP 1320, December 1993, p. 43.
85. Johnson, 1984, p. 43.
86. "Emergency Rescue during Soyuz-T 8 Failure Recalled," abstract in *JPRS Report, Science & Technology, USSR: Space*, August 19, 1987, p. 91, of an article in *Krasnaya Zvezda*, May 30, 1987, p. 4. [In the title the *JPRS Report* incorrectly identifies the Soyuz-T 10a pad abort as Soyuz-T 8, but all other information appears accurate.]
87. Lebedev, p. 153.
88. "Manned Flight Chronology," *USSR Report, Space* (JPRS-USP-84-001), January 26, 1984, p. 2-3. Compilation of transcripts of English-language broadcast reports from the Soviet news agency TASS, November 1, 3, 1984.
89. Johnson, 1984, p. 45.
90. Nicholas Johnson, *The Soviet Year in Space: 1984*, Teledyne Brown Engineering, 1985, pp. 40-42.
91. *Pravda*, March 2, 1985, p. 2. Translated in Nicholas Johnson, *The Soviet Year in Space: 1985*, Teledyne Brown Engineering, 1986, p. 54.
92. Johnson, 1986, p. 54.
93. Interview, David S. F. Portree

- with Sergei Krikalev, February 28, 1994.
94. Interview, David S. F. Portree with Sergei Krikalev, February 28, 1994.
95. Albert Ducrocq, *Air et Cosmos*, No. 1131, February 21, 1987, pp. 41-42 [original title not given]. Translated in *JPRS Report, Science & Technology, USSR: Space (JPRS-USP-87-004-L)*, June 18, 1987, p. 1, under title "French Commentator on Features of Mir Station."
96. Portree and Loftus, pp. 76-77.
97. Ducrocq, p. 5.
98. Shuttle/Mir Media Workshop, Mir Familiarization session, NASA Johnson Space Center, December 14, 1994.
99. Nicholas Johnson, *The Soviet Year in Space: 1986*, Teledyne Brown Engineering, 1987, pp. 57-58.
100. Nicholas Johnson, *The Soviet Year in Space: 1987*, Teledyne Brown Engineering, 1988, p. 84.
101. Johnson, 1988, p. 88.
102. Johnson, 1988, p. 89.
103. Johnson, 1988, p. 91.
104. Johnson, 1988, p. 94.
105. Johnson, 1988, p. 96.
106. J. Kelly Beatty, "The High-Flying Kvant Module," *Sky & Telescope*, December 1987, p. 600.
107. Johnson, 1988, p. 96.
108. Nicholas Johnson, *The Soviet Year in Space: 1990*, Teledyne Brown Engineering, 1991, p. 48.
109. Neville Kidger, "Bulgarian Set for Mir Visit," *Spaceflight*, Vol. 30, June 1988, p. 229.
110. Portree and Loftus, p. 57.
111. Interview, David S. F. Portree with Sergei Krikalev, February 28, 1994.
112. Neville Kidger, "Mir Mission Report," *Spaceflight*, Vol. 31, March 1989, p. 77.
113. Nicholas Johnson, *The Soviet Year in Space: 1988*, Teledyne Brown Engineering, 1989, pp. 102-103.
114. Interview, David S. F. Portree with Sergei Krikalev, February 28, 1994.
115. Kidger, March 1989, pp. 77-79.
116. Kidger, March 1989, p. 77-79.
117. Interview, David S. F. Portree with Sergei Krikalev, February 28, 1994.
118. Nicholas Johnson, *The Soviet Year in Space: 1989*, Teledyne Brown Engineering, 1990, p. 94.
119. Interview, David S. F. Portree with Sergei Krikalev, February 28, 1994.
120. "The Story of Soyuz-TM 9," *Spaceflight*, Vol. 33, January 1991, pp. 11-13. Interview with Solovyov and Balandin.
121. Neville Kidger, "Kristall Delay Threatens Mir Profits," *Spaceflight*, June 1990, p. 192.
122. Neville Kidger, "Cosmonauts Fly Their Space Motorcycle," *Spaceflight*, July 1990, p. 232.
123. *Spaceflight* interview with Solovyov and Balandin, pp. 11-13.
124. *Spaceflight* interview with Solovyov and Balandin, p. 13.
125. Neville Kidger, "Progress-M 7 – Catastrophe Avoided," *Spaceflight*, June 1991, p. 192.
126. Interview, David S. F. Portree with Sergei Krikalev, February 28, 1994.
127. Neville Kidger, "Helen's 8-day Mission," *Spaceflight*, July 1991, pp. 226-227.
128. Interview, David S. F. Portree with Sergei Krikalev, February 28, 1994.
129. Neville Kidger, "Austrian Mission Follows Failed Coup," *Spaceflight*, January 1992, p. 12.
130. Portree and Loftus, p. 76.
131. Neville Kidger, "Mir Cosmonauts Continue Work," *Spaceflight*, April 1992, p. 120.
132. Mikhail Arkhipov, "Flights When One is Asleep and When One is Awake," *Rossiia*, No. 20, May 13-19, 1992, p. 11. Translated in *JPRS Report, Science & Technology, Central Eurasia: Space*, November 17, 1992 (JPRS-USP-92-006), p. 26.
133. Portree and Loftus, p. 89.
134. "Cosmonauts Determine Dynamic Parameters of Space Complex," ITAR-TASS news release in English, January 28, 1993. In *JPRS Report, Science & Technology, Central Eurasia: Space*, March 25, 1993, (JPRS-USP-93-001), p. 4.
135. "TV Reports Cosmonauts' Landing, Comments on Future Flights," *JPRS Report, Science & Technology, Central Eurasia: Space*, March 25, 1993 (JPRS-USP-93-001), p. 4. Translated transcript of Novosti TV newscast by Pyotr Orlov and Vladimir Avdeyev, 1800 GMT February 1, 1993.
136. Sergei Leskov, "Gigantic Mirror in Orbit," *Izvestiya*, February 5, 1993, p. 2. Translated in *JPRS Report, Science & Technology, Central Eurasia: Space*, March 25, 1993 (JPRS-USP-93-001), p.
137. Peter B. de Selding, "Russians Deploy Reflector, Test Illumi-

- nating Idea," *Space News*, February 8-14, 1993, pp. 3, 21.
138. Valeri Baberdin, "The Siriuses: We Were in Orbit with You," *Krasnaya Zvezda*, February 26, 1994, p. 3. Interview with Tsibliyev and Serebrov translated in *JPRS Report, Science & Technology, Central Eurasia: Space*, May 16, 1994 (JPRS-USP-94-004), pp. 1-4.
 139. Donald Kessler, personal communication.
 140. Baberdin, pp. 2-3.
 141. Vadim Chernobrov, "Collision in Space," *Rossiskiy Vestnik*, January 21, 1994, p. 9. Translated in *JPRS Report*, March 22, 1994 (JPRS-USP-94-003), pp. 1-2.
 142. M. Chernyshev, "Details: Was the Incident in Space an Accident? Awards were Given Before the State Commission Drew Its Conclusions," *Segodnya*, January 26, 1994, p. 1. Translated in *JPRS Report, Science & Technology, Central Eurasia: Space* (JPRS-USP-94-003), p. 2.
 143. Shuttle/Mir Media Workshop, Mir Familiarization session, NASA Johnson Space Center, December 14, 1994.
 144. "STS-66/ATLAS-3 Mission Status Report," Status Report #1, ESA Press Office, Thursday, November 2, 1994.
 145. MIRNEWS #239, e-mail report based on monitoring of Mir transmissions, Chris Vandenberg, November 13, 1994 (forwarded by James Oberg, November 21, 1994).
 146. Vandenberg.

Station Modules and Tug Programs

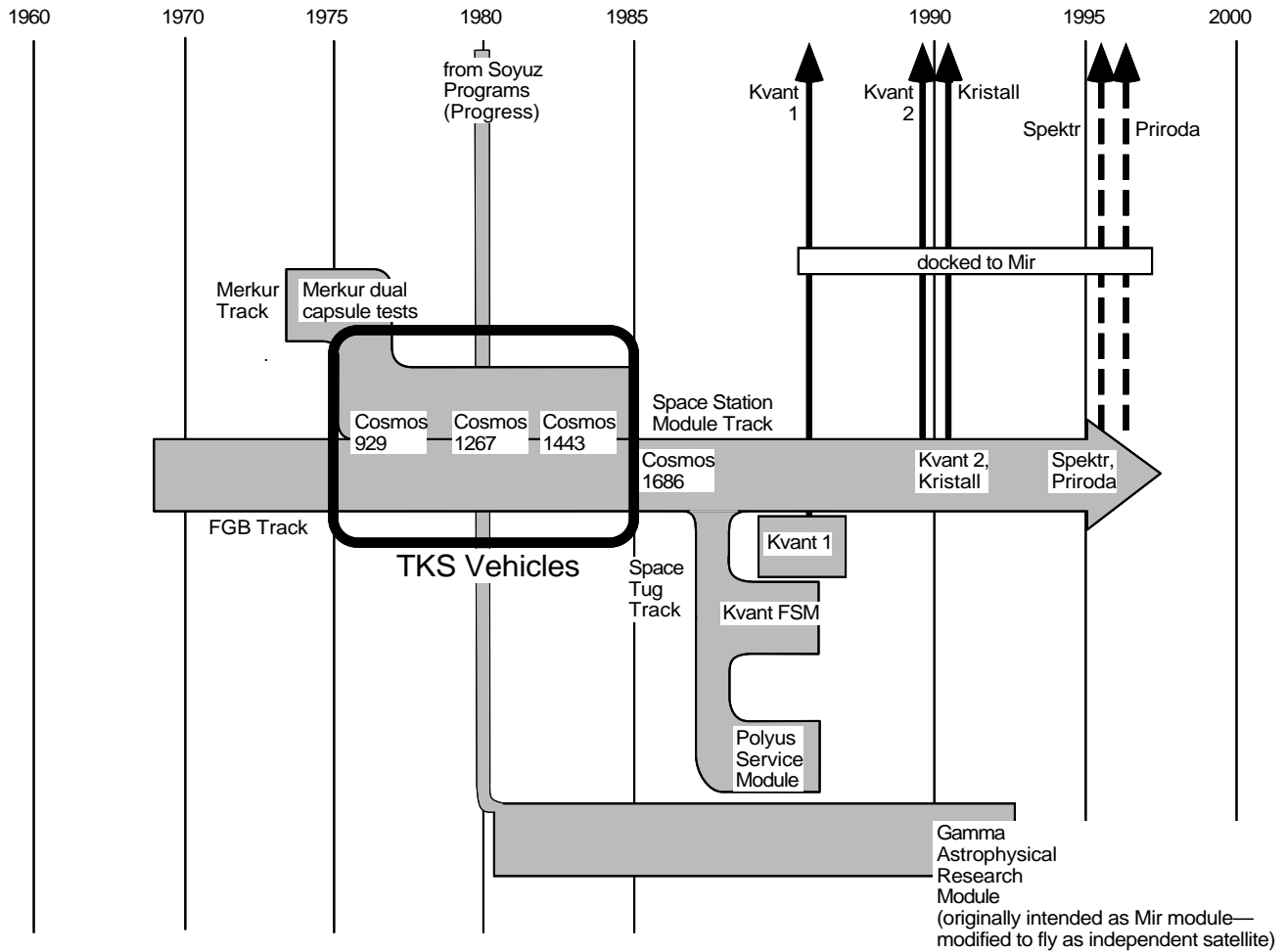

Figure 3-1. Station modules and tugs evolution. The chart above summarizes the evolution of vehicles originally developed as transport craft for the Almaz space station program and subsequently reapplied to many new functions. The narrow light gray arrow coming down from the top leads from the Soyuz Programs chart (figure 1-1). The broad gray arrows trace what is generally known in the West about the evolution of Soviet/Russian space station modules and tugs. The black-lined box encloses the TKS program, and the black arrows (solid and dashed) lead to the Station Programs chart (figure 2-1).